

DVB-T Receiver Performance Measurements Under Secondary System Interference

Jussi Kerttula and Riku Jäntti
 Communications and Networking Department
 Aalto University, School of Electrical Engineering
 Espoo, Finland
 jussi.kerttula@aalto.fi, riku.jantti@aalto.fi

Abstract—Interest to allow secondary use on television frequency bands has been growing and recently Federal Communications Commission (FCC) opened vacant TV channels for unlicensed use. Many countries, especially in Europe, are using DVB-T standard for providing terrestrial digital television transmissions, whereas countries like U.S. rely on ATSC standard. When assessing the impact and potential of secondary use, primary system's tolerance to interference must be known. In this paper we provide essential interference tolerance measurement results for DVB-T system that illustrate how secondary use could impact its performance. We show how DVB-T receivers BER behaves under interference and how bursty interference signal affects compared to continuous interference. We also calculate example protection distances for different secondary transmitters.

Keywords—DVB-T; interference; secondary use; measurements

I. INTRODUCTION

Development of new wireless services and technology is forcing us to rethink the methods how radio spectrum is allocated. Static and exclusive allocations are able to provide high protection for the licenced service, but often fail to be efficient and flexible. The inefficient use of allocated spectrum can be seen from many measurement campaigns [1] [2], but it is obvious that utilization also depends on the band. Bands such as cellular phone bands and industrial, scientific and medical (ISM) bands, are already now highly utilized. Some radio bands that seem to be underutilized may be used by aviation or safety related services that require high reliability and therefore cannot in practice be used by secondary system.

Secondary use of inefficiently used bands is an interesting possibility to improve spectrum utilization. Secondary system operates on a non-interfering basis in the same band with licenced primary system. Secondary use might be allowed to certain group of secondary users or open to every user that is willing to obey the given rules. TV frequencies have especially been under investigation in many recent studies. Switchover from analog to digital TV broadcasting has taken place in many countries already and most of the remaining countries will do it within few years. This switchover results to so called digital dividend due to increased efficiency. Digital dividend can be used to carry more channels or it can be released to some other use, such as secondary system.

When exploring the secondary use of TV bands, the effects it causes to TV reception and how it should be taken

into account in network planning process must be carefully assessed. In previous studies, interference tolerance limits for digital signal on adjacent channels are measured in [3] [4] for Advanced Television Systems Committee (ATSC) receivers and in [5] for Digital Video Broadcasting Project's terrestrial (DVB-T) receivers. These clearly show that there is significant difference in performance between different standards but also between different receivers. These measurements use Threshold Of Visibility (TOV) as a limit for the interference. TOV is in practice the same as Quasi Error Free (QEF) limit defined later in this paper. In [6] Bit Error Rate (BER) measurements have been done for DVB-T reception when interfering signal is analogue PAL-G TV-signal, but this is not comparable to digital multicarrier interference signal due to different waveform. BER is able to provide more information about the impact of interference, than simple TOV limit. Interference impact on much lower interference levels than the TOV limit is reached and BER can show this. The aim of this paper is to give an overview of DVB-T as a primary system and provide relevant interference tolerance measurement results, mostly in terms of BER, that can be used when analyzing the potential and effects of secondary use of TV-bands.

This paper is organized as follows. Section II briefly explains main features of DVB-T system that affects to secondary use. In Section III we introduce our measurement setup and methodology. Measurement results are presented in Section IV. In Section V we calculate what kind of protection distances are needed to protect the primary users. Finally, Section VI concludes our work.

II. DVB-T AS A PRIMARY SYSTEM

Television frequency band is often considered to be the most attractive part of radio spectrum for use. Television broadcasting uses relatively low frequency range that enables long link distances. Transmitter locations are static and usually they have continuous transmission with fixed channels. This information is publicly available and can be used when deciding which channels are available in specific location by using geolocation database [7]. Generally, secondary systems have to estimate spectrum availability in time, frequency and temporal domains. However, TV transmissions are usually so static and continuous that the time domain assessment can be left out, which makes the situation much simpler.

DVB-T is a widely adopted terrestrial digital television standard that is being used e.g. in most European countries. It uses orthogonal frequency division multiplexing (OFDM), where transmitted data is carried by large number of closely spaced orthogonal subcarriers. DVB-T system can utilize different combinations of parameters depending on the given performance requirements. Number of subcarriers, guard interval, modulation and code rate can be modified and these affect to the net bitrate, required carrier-to-noise ratio (C/N), mobility and possible single frequency network use. System parameters that are used in our measurements are presented in Table I. This set of parameters is used for example in Finland and Sweden and it gives 22.21 Mbit/s net bitrate [8].

When analyzing the interference tolerance limits of DTV, error correction coding plays a significant role. DVB-T system uses a kind of concatenated structure that consists of inner and outer coding. The outer code uses Reed-Solomon coding which is very robust against bursty errors, while an inner code uses convolutional coding which is good against random-type errors. In addition to these coding methods, interleaving and energy dispersal are used to improve the received video quality. DVB-T systems use MPEG-2 or MPEG-4 video compression. As a result even small bit error likely produces noticeable and irritating flaw in the video stream. Therefore the target is to produce virtually error-free bitstream after errordecoding at the receiving end. Evaluating the quality of experience, or video quality is not so relevant, since the transition from perfect to unacceptable quality is very rapid.

In practice the maximum acceptable error rate is decided to be one uncorrected error event per hour, meaning BER of 10^{-11} at the input of MPEG-2 demultiplexer, and 2×10^{-4} after inner Viterbi decoding. This error level is also called Quasi Error Free (QEF) level. Measurement results presented in this paper maps this QEF limit to about 1.5×10^{-2} BER before Viterbi decoding. For the parameters given in Table I, the minimum C/N requirements to achieve QEF level are given in [8] for Gaussian, Rician and Rayleigh channels, being 16.7dB, 17.3dB and 20.3dB, respectively. Rician channel is modeling fixed reception and Rayleigh channel model portable reception. Based on these we can estimate the minimum required power level by using following formula:

$$P_{min}(dBm) = 10 \log(kT_0BF(C/N)_{min}) + 30 \quad (1)$$

where $k = 1.3 \times 10^{-23} J/K$ is the Boltzmann's constant, $T_0 = 290K$ is the temperature, $B = 7.6MHz$ is the receiver's noisebandwidth, F is receiver's noise figure and C/N_{min} is the minimum signal quality to achieve QEF level. Result is scaled from dBW to dBm by adding 30dB. When we expect noise figure to be 8dB and Rician channel, the minimum required signal power becomes $-79.9dBm$.

Protection ratios for adjacent channel and co-channel interference are usually defined as a function of power levels between wanted TV-signal and interferer. This is also known as Desired-to-Undesired ratio (D/U). Organizations such as ITU-R, Nordig, DIGITALEUROPE/EICTA and Digital TV

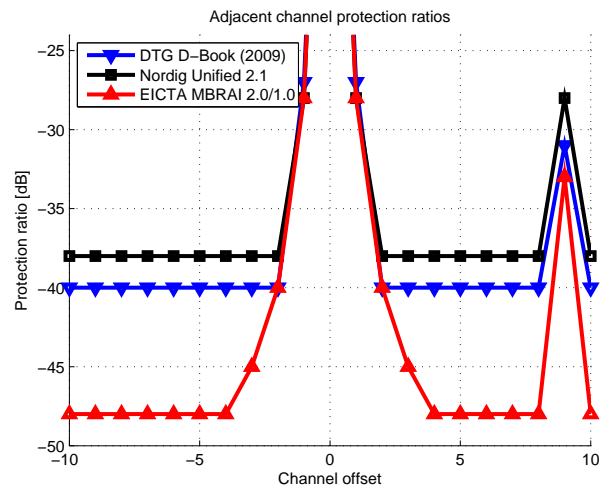

Fig. 1. DVB-T protection ratio specifications

TABLE I
DVB-T PARAMETERS

Parameter	Value
Channel bandwidth	8 MHz
FFT size	8192 (8K)
Number of subcarriers	6817
Modulation	64-QAM
Code rate	2/3
Carrier spacing	1116 Hz
Useful symbol duration	896 μ s
Guard interval	1/8

Group (DTG) provide protection ratio requirements and recommendations for receiver manufacturers and network planning purposes. Most of these specifications are presented in Figure 1. These protection ratios are given against other DVB-T transmissions. It can be seen that there is a large difference between them. Requirements are generally looser for first adjacent channels $N \pm 1$ and image channel $N + 9$ interference tolerance than other adjacent channels.

A. DVB-T coverage and network planning principles

Compared to analog TV-system, the network planning process is somewhat different for DVB-T system. This is due to the fact that in DVB-T there either is or is not coverage at certain time, whereas with analog system the coverage edge is softer. Digital coverage rapidly changes from perfect reception to no reception at all which make coverage area predictions and network planning challenging.

DVB-T coverage area definition includes time and location probabilities [9]. Receiving location is covered if service can be perfectly received some wanted percentage of time. This means that carrier-to-noise and carrier-to-interference relations are above required threshold. Next level is so called "small area" typically 100m x 100m and within this area the percentage of covered receiving locations is defined. Coverage is "good" when 95% of receiving locations are covered and "acceptable" if the number is 70%. The total coverage area that is achieved by using one or multiple transmitters consists

of a sum of these small areas that fulfill the given coverage requirements.

Theoretical propagation models are used to estimate transmitter coverage and to help network planning. Often used model for broadcast networks is the ITU-R P.1546. It gives relatively good results by taking into account e.g. terrain topography with decent amount of complexity. This model is commonly used when planning and coordinating TV-frequencies. More complex models that are based on diffraction also exist, and they can potentially provide more accurate results. These models are often used by network operators that want to optimize their network.

DVB-T networks are already now usually interference limited. In a typical implementation, interference reduces the coverage radius of a broadcast station by up to few kilometers when compared to noise limited case. The interference is caused by other TV-transmitters that are using the same channel, despite that they are usually several hundred kilometers apart. High-power transmitters in high masts and the relatively low frequencies cause that the interference distances are long. This means that it is not enough to allocate these frequencies domestically, but in many cases also international coordination is needed.

It is evident that if secondary use of TV-channels is allowed, it will cause additional interference towards TV-services. The important question is that how much additional interference should be tolerated? The effect of this additional interference could be assessed in many ways, for example in terms of coverage probability degradation.

III. INTERFERENCE MEASUREMENTS

When exploring the opportunities for secondary use, the tolerance limits for interference should be carefully determined. Tolerance limits are naturally different for different systems and different parameter sets, but limits can vary between different manufacturers significantly. In the case of DVB-T system, most of the previous interference measurements only provide the hard QEF or TOV threshold, but we see that there is a need for more detailed measurements as well.

A. Measurement setup

Measurement setup is shown in Fig. 2. DVB-T signal is first received via directional roof-top antenna. Adjustable attenuator is used to change the DVB-T signal strength down to desired level. Interfering signal is created with matlab and R&S SMJ100A signal generator. Interference signal is then summed to DVB-T signal and then split to receiver and to spectrum analyzer. Tektronix RSA6114A spectrum analyzer is used to measure all the power levels, taking the impedance match into account. Finally, the signal is fed to DVB-T receiver. The measured commercial receiver is able to give BERs before and after Viterbi decoding. Therefore it is connected to computer that records these values for later use and analysis. Also visual quality of the received video stream can be analyzed via television. QEF limit can also be found by visual assessment with about $\pm 1dB$ accuracy.

TABLE II
INTERFERENCE SIGNAL PARAMETERS

Parameter	Value
Bandwidth	8 MHz
FFT size	2048 (2K)
Used subcarriers	1728
Modulation	QPSK
Carrier spacing	4464 Hz
Symbol duration	224 μ s

B. Measurement methodology

Measurements are conducted at about 10 km distance from a large DVB-T broadcast station. Channel #32 (558-566 MHz) was used as a desired channel and signal strength at the receiver's input is $-57dBm$ without added attenuation. Interference signal for all measurements is OFDM-signal and its detailed parameters are shown in Table II. During each interference measurement, the DVB-T signal strength is constant and interference signal is changed.

Our measurements consisted of three different cases. First receiver sensitivity and co-channel interference tolerance were measured. The second case measured adjacent channel interference tolerance for channels $N \pm 1$ and $N \pm 2$. Third case examined how the effects of a non-continuous bursty interference signal differ from a continuous interference signal. In real scenario it is likely that secondary users don't have constant transmissions, but they can be timevariant. Bursty signal is created by switching the same interference signal between ON and OFF states. Our focus is not to provide only TOV or QEF limit but to show in more detailed manner how the BER behaves when interference is present. Most of our measurements are done with Receiver-1, which is able to give the BER numbers, but for comparison we also tested visually the interference tolerance limits with two other commercial receivers referred as Receiver-2 and Receiver-3.

IV. MEASUREMENT RESULTS

This section presents and analyzes the obtained measurement results.

A. Sensitivity and co-channel interference

Sensitivity of the DVB-T receiver was measured by attenuating the received signal level. Since we used fixed roof-top antenna, the radio channel is expected to be Rician. Figure 3 shows the BERs before and after Viterbi decoding as a function of signal power. It can be seen that the Viterbi decoding can correct all the errors when received power is over $-75dBm$. The QEF limit is then reached at power level of $-79dBm$. This is close to the simulated power limit presented earlier in this paper. This $-75dB$ limit is also chosen to be used in most of the measurements in this paper, because it can be considered to be the power level close to cell border.

Co-channel interference tolerance was measured with $-75dBm$ desired DVB-T power level. Results are shown in Figure 4. It can be seen that interference does not cause noticeable effect when D/U ratio is more than $28dB$. The QEF limit is achieved at $22dB$ D/U ratio. ITU-R BT.1368-8 gives

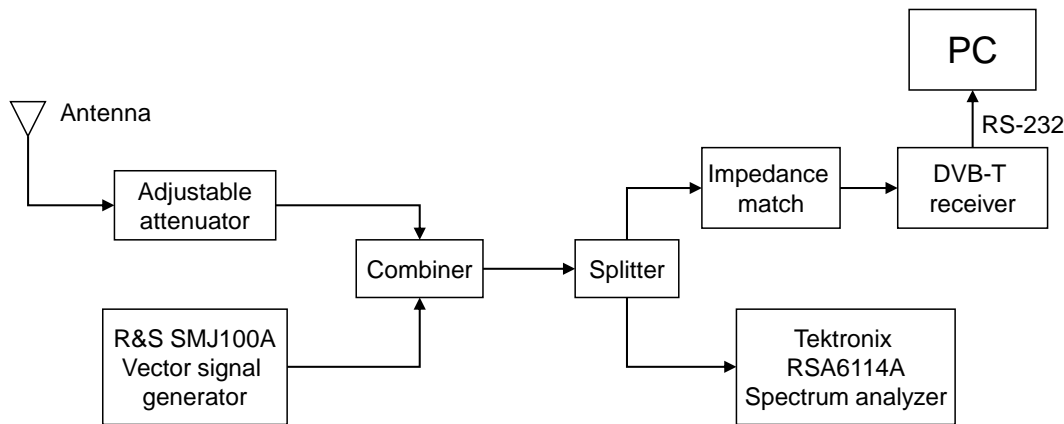

Fig. 2. Measurement setup

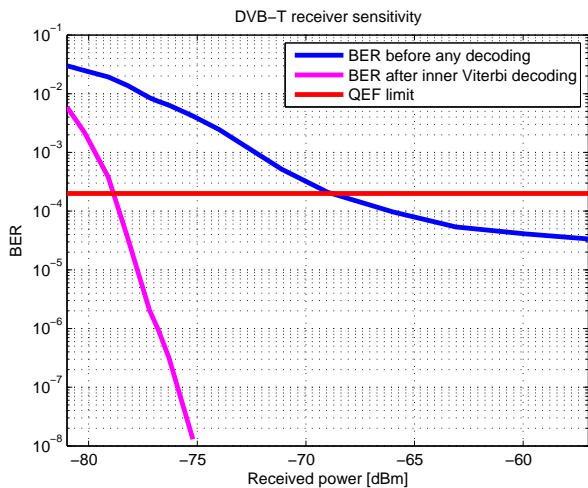

Fig. 3. DVB-T receiver sensitivity

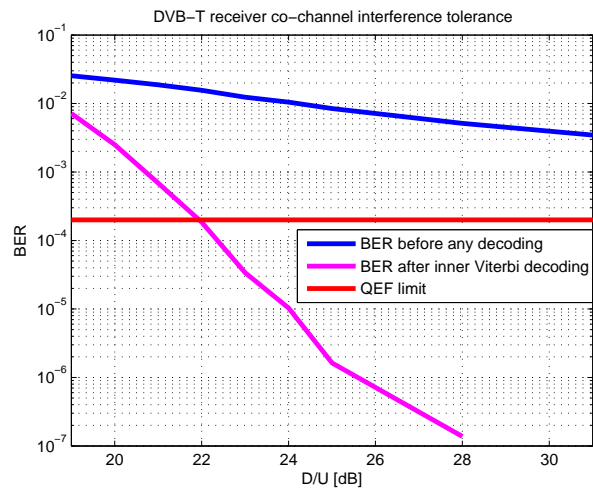

Fig. 4. Co-channel interference tolerance

protection ratios between two interfering DVB-T signals. For these used parameters the ratios are 19dB, 20dB and 23dB for Gaussian, Rician and Rayleigh channels, respectively.

B. Adjacent channel interference

Adjacent interference tolerance determines whether a guard channel is needed between the primary and secondary user or what kind of guard distance should separate them. Measured results for $N \pm 1$ are shown in Figure 5. It can be seen that $N + 1$ interference starts to degrade the BER when D/U is less than $-20dB$. For $N - 1$ interference the performance is better and the interference begins to affect when D/U is less than $-30dB$. However the QEF limits are reached with D/U ratios $-30dB$ and $-35dB$, for $N + 1$ and $N - 1$, respectively. ITU-R BT.1368-8 gives $-30dB$ protection ratios for both $N \pm 1$ channel interference. Tolerance for $N \pm 2$ channel interference are presented in Figure 7. Again it can be seen that $N - 2$ channel tolerates more interference than

$N + 2$. The QEF limits for $N \pm 2$ channels are about 12dB lower D/U level than for $N \pm 1$. Protection ratios for all the measured receivers are presented in Table III. It can be observed that Receiver-2, which is an USB-stick type receiver, have significantly worse tolerance for interference on adjacent channels beyond $N \pm 1$ and it does not even meet the loosest Nordig specification. Receiver-1 and Receiver-3 are both set-top boxes, and also their interference tolerance is much better, meeting more stringent EICTA MBRAI requirements.

In order to see how desired power level affects to the interference tolerance, we also measured $N+1$ channel interference using different desired power levels. These results are shown in Figure 6 where only BERs before Viterbi decoding is plotted. As seen from the other figures, the QEF limit is approximately 1.5×10^{-2} and this is also plotted in the figure. The impact of noise naturally decreases when desired power is stronger. Due to this, the QEF limits, in terms of D/U ratio, are not the same for every desired signal strength. Stronger desired

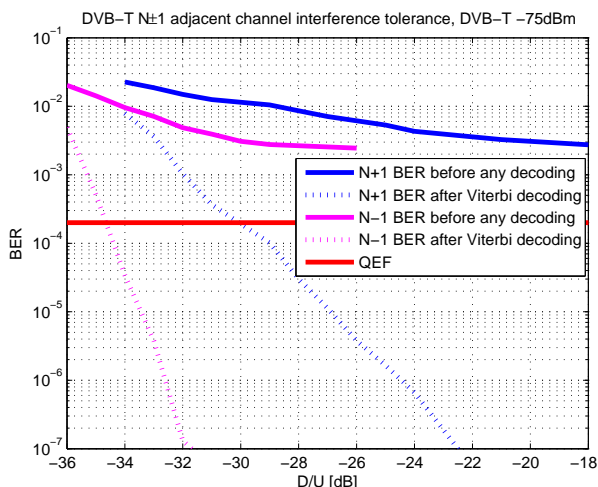

Fig. 5. $N \pm 1$ Adjacent channel interference tolerance

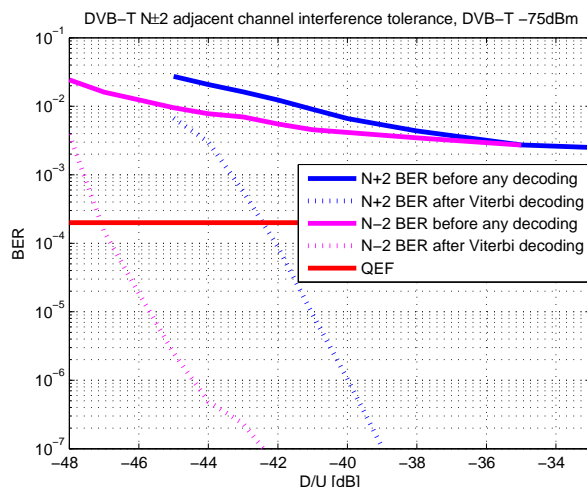

Fig. 7. $N \pm 2$ Adjacent channel interference tolerance

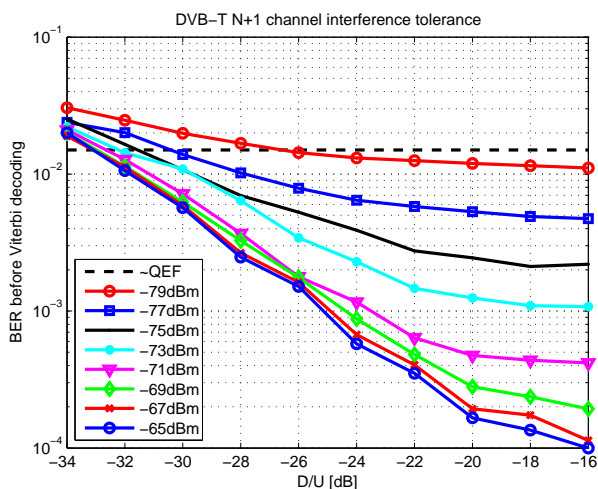

Fig. 6. $N + 1$ Adjacent channel interference tolerance with different desired power levels

TABLE III
MEASURED D/U PROTECTION RATIOS, DVB-T POWER $-75dBm$

	N-3	N-2	N-1	N	N+1	N+2	N+3
Receiver-1	-50	-47	-34.5	22	-30	-42.5	-48
Receiver-2	-24	-26	-25	21	-30	-31	-32
Receiver-3	-45	-40	-34	21	-36	-46	-52

signals can tolerate more interference even in terms of D/U ratio. However, with this change is not significant when desired signal is stronger than $-75dBm$, as seen from this figure.

C. Bursty interference

Bursty interference tolerance is measured by visually determining the QEF limit, because bursty interference causes the BER to vary significantly and therefore these values don't give reliable results. Four bursty signals with different transmit/silence ratios were used, and then also continuous signal were measured for comparison. Shortest transmission

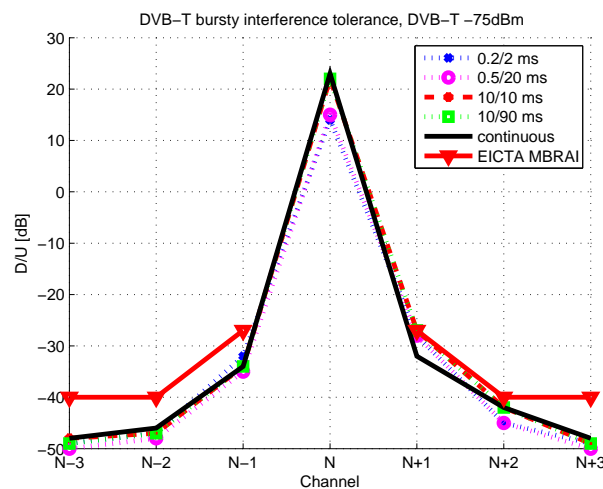

Fig. 8. Bursty interference tolerance, QEF limits

bursts were $0.2ms$ long and longest were $10ms$. The results are presented in Figure 8 along with the EICTA MBRAI protection ratios. It can be seen that on co-channel the very short bursts could operate about at about $6dB$ higher power level. This improvement disappears or reduces on adjacent channels. This receiver also fulfils the EICTA MBRAI specification. The average BER is normally slightly lower with bursty interference signal compared to equal strength continuous one, but BER during the burst determines whether errors occur or not. Overall it can be said that there is no significant difference between the bursty and continuous signal tolerances.

V. PROTECTION DISTANCES

Interference tolerance levels of the primary systems is one of the parameter that determines what kind of secondary use is possible and how long the protection distances should be between secondary transmitter and primary receiver. The limits are difficult to put into right perspective as plain dB values,

but based on them and by assuming something about the secondary system, we can calculate example cases about the protection distances.

Let us assume that we have a DVB-T receiver with fixed antenna at 10m height, located at the edge of the coverage area. According to the Reference Planning Configurations (RPC) defined in [10], the corresponding minimum field strength E is $56dB\mu V/m$. Now receiver input power can be calculated if we know possible losses and antenna gain to transmitter direction by using following equation

$$P[dBm] = E[dB\mu] + G + 10 \log\left(\frac{\lambda^2}{4\pi}\right) - 10 \log(120\pi) - 90 \quad (2)$$

where antenna gain G also includes the losses. Assuming that $G = 1.7dB$ to the direction of wanted signal and $600MHz$ frequency, minimum input power becomes $-75dBm$.

Let us use three different type of secondary transmitters, representing Wireless Regional Area Network (WRAN), Wireless Local Area Network (WLAN) and Wireless Personal Area Network (WPAN) -type transmitters with Effective Radiated Powers (ERPs) of $26dBm$, $20dBm$ and $10dBm$, respectively. Propagation loss $L(d)$ is calculated using modified Hata model given in [11] for suburban environment. If the transmitting antenna is located indoors, we assume that the indoor-outdoor propagation causes additional $6dB$ attenuation. Now we can calculate the minimum protection distance d from equation

$$P_{DVB} - PR = P_{sec} - L(d) \quad (3)$$

where P_{DVB} is the received DVB-T power, PR is the protection ratio for secondary interference and P_{sec} is the ERP power of secondary transmitter. We assume that DVB-T receiver antenna is located at 10m height and it has $0dB$ gain to the direction of interfering secondary transmitter. Protection distances for different secondary transmitters are presented in Table IV. It can be seen that co-channel use requires several hundreds of meters protection distances even with small power devices. Adjacent channel protection distances range from less than meter up to 190 meters, but still $20dBm$ WLAN-type secondary transmitter can interfere neighbors TV. Now we assumed that DVB-T uses almost isotropic antenna and there is only one secondary interferer. In practice, DVB-T reception is often done with directive roof-top antennas with gains of $10 - 15dB$ for the main lobe and less than $0dB$ gains elsewhere. This reduces the interference in most cases, but if the interferer hits the main lobe when being between DVB-T receiver and transmitter, interference increases significantly. This is difficult to avoid. We might also have multiple interferers on different adjacent channels, causing cumulative effect.

VI. CONCLUSION

In this paper we have presented measurement results of DVB-T receiver performance when single transmitter is causing interference. We use BER as a performance metric that provides more information than visual error free assessment. Visual errors begins to occur when BER after inner Viterbi

TABLE IV
PROTECTION DISTANCES

Channel (PR)	Secondary ERP and antenna location			
	26dBm out 10m	20dBm out 5m	10dBm in 5m	10dBm in 2m
$N(22dB)$	5800m	950m	640m	310m
$N \pm 1(-30dB)$	190m	50m	40m	21m
$N \pm 2(-42dB)$	90m	20m	8m	< 1m

decoding reaches 2×10^{-4} . Conducted measurements show that interference begins to degrade BER several dBs before errors can be visually seen. Tolerance for bursty interference is almost similar compared to continuous interference and therefore same limits can be used for both. However, deciding the protection limits against secondary use is a challenge since different organizations have difference in their specifications and in practice the interference tolerance varies significantly between receivers. From calculated protection distances it can be concluded that in most cases WLAN-type or smaller transmitter can operate on adjacent channels without causing too much interference, especially if secondary transmitter is located indoors and one guard channel is left between it and TV-channel.

ACKNOWLEDGMENT

The research leading to these results has received funding from the European Union's Seventh Framework Programme FP7/2007-2013 under grant agreement no. 248303.

REFERENCES

- [1] M. Lopez-Benitez, A. Umbert, and F. Casadevall, "Evaluation of spectrum occupancy in Spain for cognitive radio applications," in *Proc. IEEE 69th Vehicular Technology Conf. VTC Spring 2009*, 2009, pp. 1-5.
- [2] M. A. McHenry. (2005) Nsf spectrum occupancy measurements projects summary. Shared Spectrum Company. [Online]. Available: <http://www.sharedspectrum.com/measurements/>
- [3] G. L. Stuber, S. M. Almalfouh, and D. Sale, "Interference analysis of tv-band whitespace," *Proc. IEEE*, vol. 97, no. 4, pp. 741-754, 2009.
- [4] K. Salehian, Y. Wu, and G. Gagnon, "Performance of the consumer atsc-dtv receivers in the presence of single or double interference on adjacent/taboo channels," *IEEE Trans. Broadcast.*, vol. 56, no. 1, pp. 1-8, 2010.
- [5] B. Randhawa and S. Munday, "Conducted measurements to quantify dvb-t interference into dtb receivers," ERA Tech./Ofcom, Tech. Rep., October 2007.
- [6] M. M. Velez, P. Angueira, D. De La Vega, A. Arrinda, and J. L. Ordiales, "Dvb-t ber measurements in the presence of adjacent channel and co-channel analogue television interference," *IEEE Trans. Broadcast.*, vol. 47, no. 1, pp. 80-84, 2001.
- [7] M. Nekovee, "Cognitive radio access to tv white spaces: Spectrum opportunities, commercial applications and remaining technology challenges," in *Proc. IEEE Symp. New Frontiers in Dynamic Spectrum*, 2010, pp. 1-10.
- [8] ETSI EN 300 744, "Digital video broadcasting (dvb); framing structure, channel coding and modulation for digital terrestrial television," Jan 2009.
- [9] ETSI TR 101 190, "Digital video broadcasting (dvb); implementation guidelines for dvb terrestrial services; transmission aspects," Oct 2008.
- [10] ITU-R, "Final acts of the regional radiocommunication conference for planning of the digital terrestrial broadcasting service in parts of regions 1 and 3, in the frequency bands 174-230 mhz and 470-862 mhz (rrc-06)," 2006.
- [11] ITU-R SM.2028-1, "Monte carlo simulation methodology for the use in sharing and compatibility studies between different radio services or systems," 2002.