

Communication Network Architectures based on EPON for Offshore Wind Power Farm

Mohamed A. Ahmed

Department of Computer Engineering
Chonbuk National University
Jeonju, Korea
mohamed@jbnu.ac.kr

Young-Chon Kim

Smart Grid Research Center
Chonbuk National University
Jeonju, Korea
yckim@jbnu.ac.kr

Abstract—Wind power gains a great attention among renewable energies because of its relative cost competitiveness and the maturity of the technology. This paper proposes the EPON-based communication network architectures as a promising candidate to replace the current switched-based networks for wind power farm (WPF). EPON-based networks combine the advantages of both the optical network technology and Ethernet technology. The proposed WPF network architecture is based on the electric transmission topology and consists of a central optical line terminal (OLT) placed in the control center and optical network units (ONUs) deployed on the wind turbines (WTs) side. There are no active electronic devices used between the OLT and the WT-ONUs to reduce the cost and complexity of maintenance and deployment. Two different EPON-based architectures for an offshore WPF have been proposed and compared in terms of optical power budget, path loss and network cost. The power budget is analyzed to ensure that the received signal power is enough to maintain acceptable performances even though the lengths of communication link between the control center and WTs are different. The total path loss includes the power reduction from fiber, connectors and splitters. The results show that the received power of each WT in EPON-based architecture satisfies the power budget requirements of IEEE standard. Also, the analysis of network elements shows that EPON-based architectures have a cost effective solution.

Keywords—smart grid; SCADA; EPON; power budget; wind power farm.

I. INTRODUCTION

Nowadays, large-scale wind power farm become a reality. Many offshore projects were scheduled to be constructed in the coming years, to overcome the fossil fuel dependence, and reduce CO₂ emissions. These platforms represent many engineering challenges related to electrical connectivity and communication infrastructures [1]. Current communication infrastructures were designed several decades ago, based on old technologies that have a low bandwidth such as telephone lines which need to be upgraded. To meet the demand of control operations and smart grid applications, communication infrastructures need fundamental changes to be reliable, scalable and extendable to future services and applications [2]. Supervisory control and data acquisition (SCADA) is the basis for monitoring, control and data gathering of wind power farm (WPF). It allows for remote

control, monitoring of individual turbines, and monitoring the wind farm as a whole from central control station or from a remote control center. Furthermore, it enables full communication with the operator, manufacturer and maintenance staff [3].

Ethernet passive optical network (EPON) technology is an optical access network, designed to serve customers with voice, video and data services. EPON is broadly deployed in Korea and Japan while GPON (Gigabit PON) is widely deployed in parts of the U.S. and Europe [4]. EPON-based networks were developed to solve the bandwidth bottleneck in the access network. Recently, many researchers have begun to address the applications of EPON technology in smart grid and power system.

In China, there are many successful installations of communication network based on EPON technology in electric power system such as Yangjiaping power distribution [5]. Also, the authors in [6] present an integrated communication platform of a photovoltaic (PV) power station, which integrates EPON, power line carrier and wireless communication. The authors of [7] propose transmission lines monitoring system based on long distance EPON and wireless technology of Wi-Fi.

Modern large-scale WPFs are located at offshore, with growing in wind farm size (number of WTs) and wind turbine capacity. These platforms represent great challenges in view of accessibility, reliability, cost and maintenance. The conventional communication infrastructures are switched-based, where each wind tower comprises an Ethernet switch (ESW) to interconnect communication devices inside the wind tower and the ESW requires electric power supply in the WPF field [8]. The prices of these industrial switches are expensive compared with the normal Ethernet switch [9]. The EPON is one of the promising candidates for next generation WPF because it provides high performance communication network with low cost, low power consumption and high reliability. The EPON doesn't use active components between OLT and ONUs. This may result in the limitation of growing wind farm size because optical power budget operates as a bottleneck for EPON-based WPF architectures.

In this paper, we proposed two different communication network architectures based on EPON technology for offshore WPF. The power budget is calculated and compared to ensure that the received signal power is enough to

maintain acceptable performance under all conditions, due to limitation of EPON optical power. The optical power budget calculation in this paper includes losses in fiber, connectors and splitters. Also, we analyze the network cost to ensure the advantages of proposed architectures.

The rest of this paper is organized as follows. Section 2 presents the related work. In Section 3, the WPF layout is described. Section 4 details the proposed EPON-based network architecture with two different configurations; architecture (A) and (B). Section 5 shows the optical power budget, path loss and network cost calculation and discussion. Finally, Section 6 presents the conclusion and the direction of future work.

II. RELATED WORK

A. WPF Architecture

First, The WPF consists of individual WTs connected together, and tied to the collector system. From the electrical topological point of view, the WTs are connected to the utility system through transformers and distribution lines, including one or more meteorological mast [10]. From the communication network point of view, the WPF includes the integration of SCADA systems, wind power management systems, protection and control systems, and various intelligent electronic devices (IEDs) [11].

The information gathered from the WPF is processed for control and protection functions. Logically, according to IEC 61850, the WPF comprising of three levels; process level, bay level and station level. In the process level, sensors and IEDs transmits/receives small raw/control data packets [12]. At the station level, different devices are existing including for example; WTC (wind turbine controller), condition monitoring system (CMS), HMI (human machine interface), circuit breaker (CB) control, metering server, meteorological server and WPF server. Fig. 1 shows the WPF information flow, where each server provides information of, or controls to its devices.

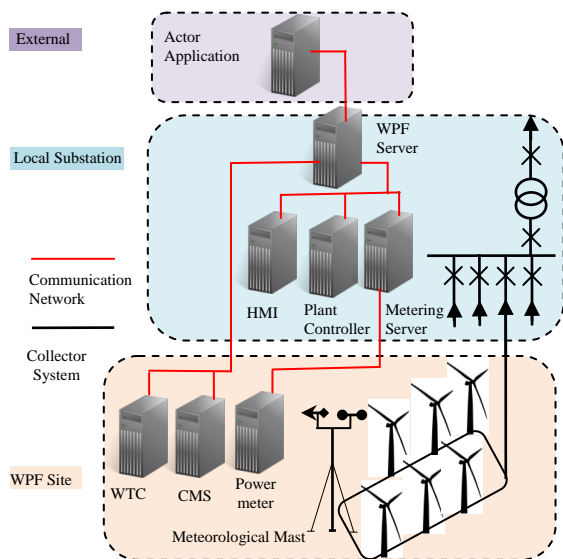

Figure 1. Logical architecture of WPF

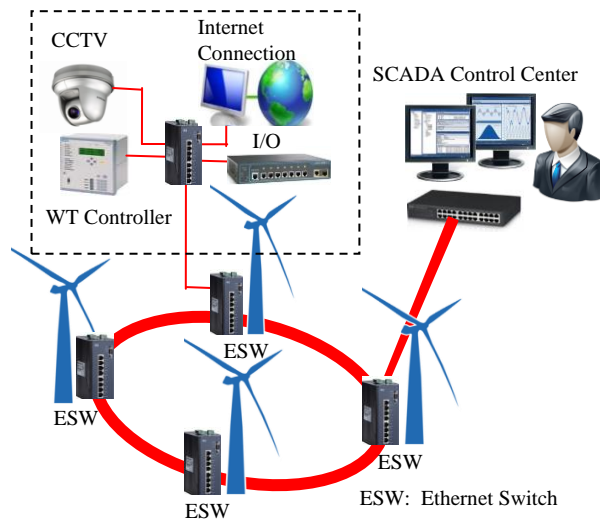

Figure 2. Schematic view of conventional WPF network [14]

B. Switched-based Communication Networks for WPF

The communication systems for WTs can be classified into two different categories [13][14]:

a) **Inside the turbine tower**, including the WT controller, sensors and IEDs. This network supports different traffic such as CCTV system and internet connection to enable monitoring and controlling of the WT tower, as shown in Fig. 2;

b) **Between wind turbines** (within the WPF), including the connection between wind towers. This part constitutes the SCADA system. Due to the high cost of laying cables, optical fibers are integrated with the medium voltage and may follow the electrical topologies. The most widely types of communication networks are radial, ring and star.

III. WIND POWER FARM LAYOUT

A. Offshore WPF-Collector System Layout

We designed the EPON network architectures based on the electric system layout of medium size offshore WPF, with four radials, 48 WTs and different cable lengths as shown in Fig. 3. All electric radial cables are connected to the offshore platform where the voltage is stepped up and the power is transmitted to shore. The circuit breakers and the main protection instruments are configured at different regions of the system [15][16]. The WPF is divided into four groups with 2Km space between each other. Each group is served by an electric power cable connected from the offshore platform to the nearest WT. Inside each group; the spacing between individual WTs is equivalent to 1Km along rows and between rows.

The longest cable length between the offshore platform and WTs is 4.47Km, connected to WT-B01 and WT-G01, while the short cable length is 2.23Km connected to turbines WT-D01 and WT-E01. The submarine cable between the point of common coupling (PCC) from grid side and the offshore platform is 5Km. Due to the high cost of laying

cables; the logical option is to use the same power distribution cable routes for the SCADA communication network. In this work, the optical fibers are integrated within the electric submarine cables, therefore the communication network follow the wind farm electrical topology.

B. Design of WPF Communication Network Based on EPON Technology

EPON technology is an optical access network, consists of optical line terminal (OLT), optical network units (ONU), and passive optical splitter (POS). The physical layer uses PON technology while MAC layer uses the Ethernet technology which combines the advantage of low flexibility, low cost and high bandwidth [17]. Fig. 4 shows the proposed structure of the WPFs based on EPON technology. There are three main architectures; architectures (A&B) represent the design of new planned WPFs, while architecture (C) illustrates modifying existing WPFs to support EPON technology.

The proposed network model consists of ONU deployed on the WT side, for collecting data from different internal networks. All ONUs from different WTs are connected to a central OLT, placed in the control center. There are no active electronic elements used between the ONUs and the OLT, which reduce the costs and complexity of maintenance and deployment.

PON network architectures include different configuration such as star, ring and bus which can be applied for different WPF configurations. Also, it can be deployed in a redundant configuration as a double ring or a double tree. In Fig. 4, in control center side, there are two OLT connected to different WPF servers through Ethernet networks.

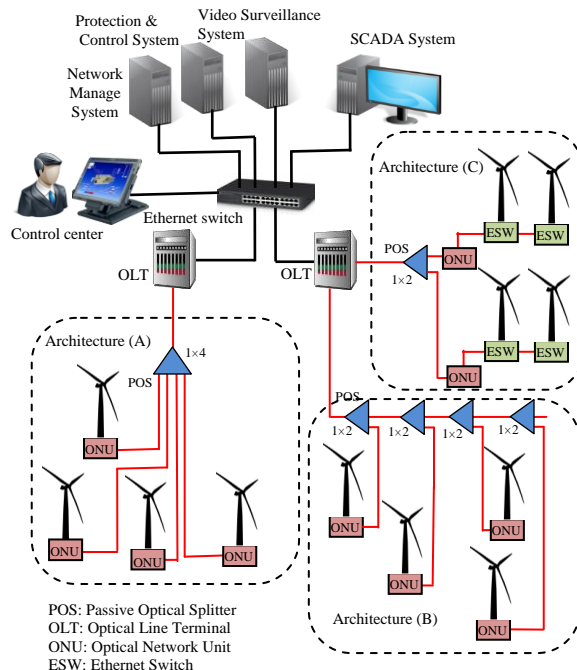

Figure 4. Schematic view of proposed EPON-based architectures for WPF

Architecture (A) represents star configuration, there are four ONUs connected to one POS using distributed fibers, where one ONU supports one standalone wind turbine traffic. In architecture (B), there are four POSs connected in cascade, each ONU supports standalone WT traffic.

Architecture (C) shows the radial design, where all WTs are connected in series to one feeder. This hybrid architecture comprises both Ethernet switches (ESW) and ONUs. The traffic from each feeder is supported by one ONU, transmitted to control center through POS. All transmissions in a PON are performed between OLT and ONUs. Therefore, in the downstream direction (from OLT to ONUs), PON is a point to multipoint network, while in the upstream direction; it is a multipoint to point network.

IV. EPON-BASED NETWORK ARCHITECTURE

This section considers two different network architectures for WPF. All WTs are connected together in a radial topology from WTs (A01→A06) till WTs (H01→H06) as shown in Fig. 3. We assumed that:

- An OLT unit is installed in the control center;
- Each WT has only one ONU device;
- Different network architectures are designed, using feeder fiber (FF), distributed fiber (DF) and passive optical splitter (POS).

For simplicity, the detail description of communication network for one group is given in more details, which is applicable for the whole WPF. The primary POS (1×8) is located on the offshore platform. Part of its output ports are connected to the four WT groups, while the remaining ports are connected to IEDs and protection devices located on the offshore platform.

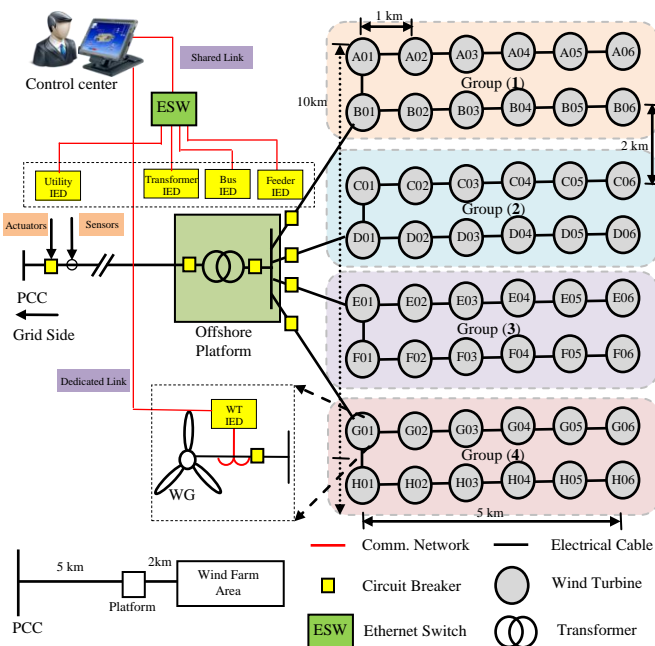

Figure 3. Layout of wind power farm with four radials and 48 WTs

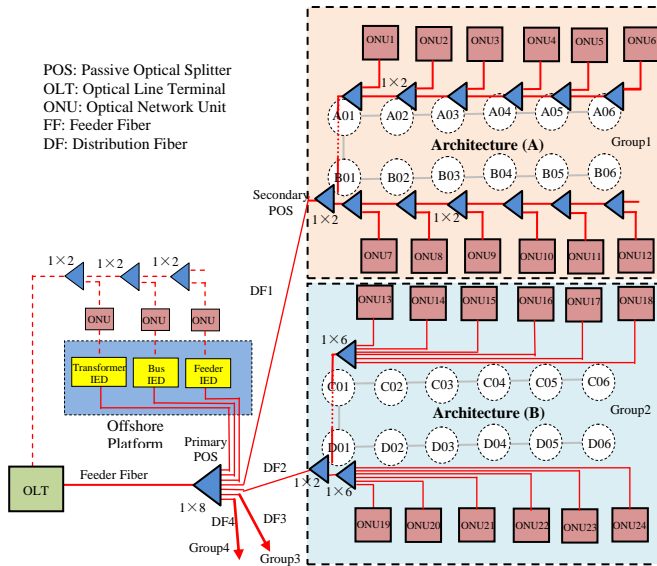

Figure 5. Schematic view of a medium size WPF

TABLE I. NETWORK ELEMENTS OF WPF

	# OLT	FF [Km]	# Prim. POS	Sec. FF [Km]	# Sec. POS	# Other POS	Other DF [Km]
A	1	5	1 (1x8)	13.4	4 (1x2)	48 (1x2)	44
B	1	5	1 (1x8)	13.4	4 (1x2)	8 (1x6)	124

Architectures A: This begins with an OLT unit located in the control center, connected with a 5Km feeder fiber to the primary POS (1x8) located on the offshore platform. Cascade splitters are used to reduce the amount of deployed fiber in the network. The primary POS is connect to secondary POS in WT-B01, while the other output ports are connected to other secondary POS located at WT-D01, WT-E01, WT-G01 respectively. The WT-B01 has the two identical POS (primary and secondary); both are (1x2). For all other wind turbines (WT-A01→WT-A06 and WT-B02→WT-B06), each WT has only one POS (1x2); one port is connected using DF to the next WT, while the other port is connected to the WT-ONU unit.

Architectures B: It differs from configuration (A) as it has less number of POS. Secondary POS is (1x2), the same like configuration (A). The first output port from secondary POS is connected to another POS (1x6) exist in WT-D01 with six output ports. Each WT from (WT-D01→WT-D06) has dedicated optical fiber cable from WT-D01. Also, the POS exist in WT-C01 is (1x6) connects a dedicated path to (WT-C01→WT-C06). Group (2) in Fig. 5 shows the network elements of configuration (B).

V. PERFORMANCE ANALYSIS

In this section we will study the performance of proposed WPF architectures with respect to power budget, path loss

and network cost. In our network model, the OLT located in control center use a single port to serve the 48-WTs through different POS. There is no splices exist in the fiber link in our calculation. Passive optical splitters with split ratio of (1x2) and (1x8) are used for WPF configuration. The OLT transmits its downstream data to WTs over single-mode fiber (1000BASE-PX20-D) which supports at least 20 Km with 1490nm, while each WT transmitted its upstream data to control center at 1310nm. Both upstream and downstream operate at 1.25Gbps [17][18].

A. Optical Power Budget

In case of 1000Base-PX20, the power budget for EPON specified in IEEE 802.3ah is 26 dB, including channel insertion loss, dispersion and noise. Table 2 shows the EPON specification according to IEEE 802.3ah standard.

The optical budget [dB] in Equation (1) is the difference between the minimum transmitter launch power (P_{tx},dBm) at the input of the optical link, and the minimum sensitivity of the receiver (P_{rx},dBm) at the output of optical links.

$$\text{Power Budget} = P_{tx} - P_{rx} \tag{1}$$

Along the communication link, there are many sources of attenuation including, connections, splitters and the fiber cable itself. The total insertion loss must be less than the value of power budget [19]. The total power loss (Ps) of passive components of optical link given in [dB] is calculated as shown in Equation (2). Note that, a safety margin due to aging of the Tx/Rx elements, and the effect of temperature should be considered in total optical power loss calculation.

$$P_s = I_{L_{cable}} \text{Length} + I_{L_{conn}} N_{conn} + I_{L_{split}} \tag{2}$$

Where:

- I_{L_{cable}} : Insertion loss for cable [dB/Km]
- Length : length of cable from OLT to ONU
- I_{L_{conn}} : Insertion loss per connector [dB]
- N_{conn} : number of connectors (optical connection pairs)
- I_{L_{split}} : Insertion loss for splitters [dB]

TABLE II. IEEE STD 802.3 EPON SPECIFICATIONS [18][20]

Parameter	Data rate	Power budget
EPON	1.25Gb/s (D &U)	PX-20U 26 dB
	1000Base-PX20	PX-20D 26 dB
ExEPON	1.25Gb/s (D &U)	PX-30U 29dB
	1000Base-PX30	PX-30D 29dB
	1000Base-PX40	PX-40U 33dB PX-40D 33dB

TABLE III. COMPONENT INSERTION LOSS[7]

	Fiber	Connector	Splitter		
Attenuation	0.4 dB/Km	0.2 dB	1x2 (5%:95%) 0.4 dB	1x2 (50%:50%) 3 dB	1x8 9 dB

We considered the fiber attenuation is 0.4dB/Km, and the connector loss is 0.2dB. Passive optical splitter (1×2) insertion loss is 0.4dB for split ratio of 5%:95%, while the insertion loss is 3dB for split ratio of 50%:50%, as shown in Table 3.

Figures (6, 7) show the total optical path loss calculation for 24 WTs of architectures (A&B) from WT-A01to WT-D06. The remaining WTs from WT25 to WT48 are not shown as the WPF is symmetrical with same dimensions and configurations. In Fig. 6, group (1) represents 12 WTs connected in radial topology. With 1Km between WTs, fiber attenuation is 0.4 dB, connector loss is 0.4 dB and POS has the insertion loss of 0.4 dB. This is reason why the total loss appears to be growing linearly. The highest optical path loss value represents the farthest turbine (A06), about 24.18 dB, while the lowest value represents the nearest turbine (D01), about 16.89 dB. Considering the IEEE 802.3 standard, architecture (A) satisfies the requirements. In Fig. 7, the highest value of optical path loss for (A06) is about 28.78 dB, while the lowest value for WT19 is about 25.49 dB.

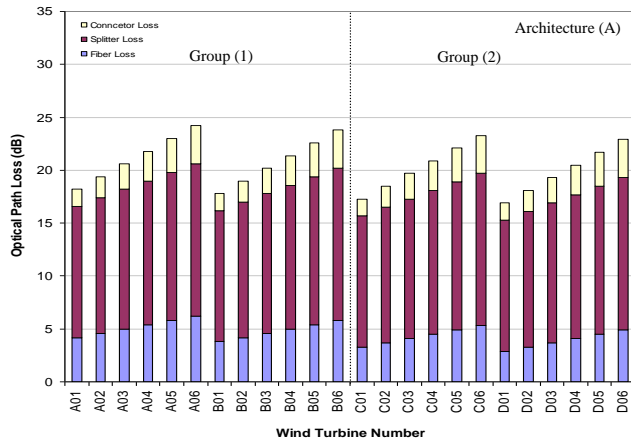

Figure 6. Total optical Path Loss of WPF- Architecture (A)

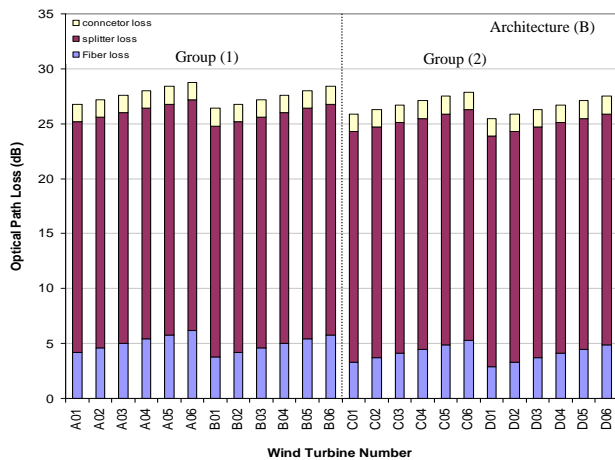

Figure 7. Total optical Path Loss of WPF- Architecture (B)

In architecture (B), the connector loss and POSs insertion loss are not changing according to distance: about 1.6 dB and 21 dB, respectively. Each WT has a dedicated fiber to the secondary POS with fiber attenuation loss of 0.4 dB/Km. The dominant part of path loss is related to primary POS with 1:8 split ratio. Thus, architecture (B) does not fulfill the required of power budget. If we consider the new power budget classes (PX-30, PX-40) for symmetric (1/1G) as shown in Table 2, both network architectures will fulfill the required power budget [20]. If we re-configured the network architecture by placing the OLT unit at offshore platform, and connect each WPF group using dedicated optical fibers (DF1→DF4). In this case, we could eliminate the path loss of the POS (1×8), which has a significant contribution to the path loss. For architecture (B), the highest value of path loss for (A06) will be 17.38 dB, while the lowest value for (D01) will be 14.1 dB. We believe that the industry will provide optical components with lower insertion loss which increases the launch power and improve the receiver sensitivity.

B. Network Cost

Capital expenditure (CAPEX) consists of both initial network equipments, and network installation costs [15]. In this work, the submarine cable comprises the electrical collection cables and optical fiber cables. Because the communication network part is integrated with the electrical system, we consider only the network equipment cost to evaluate and compare different network architectures. The network cost is calculated as follows:

$$C_{EPON} = C_{OLT} + C_{FF} + C_{POS} + C_{DF} + N_{ONU} \cdot C_{ONU} \quad (3)$$

where C_{OLT} , C_{POS} and C_{ONU} represent the equipment of OLT, POS and ONU, respectively. C_{FF} and C_{DF} represent the costs of optical fiber cable of feeder fiber (FF) and distributed fiber (DF), respectively. N_{ONU} represents the number of WTs-ONUs.

Fig. 8 shows the network cost for different WPF layouts and sizes: 12WTs, 24WTs and 48WTs. EPON-based architectures have the lowest cost compared with switched architectures. Architecture (A) is about 42,284 US \$ for 48WTs, and about 59,084 US \$ for architecture (B). Compared with switched-based architecture with consists of optical fiber cables and Ethernet switches, the network cost is 99,984 US \$. The comparative cost analysis shows that EPON-based architectures are a cost effective solution for wind power farm.

TABLE IV. COMPONENT COST [21]

Components	Cost (US \$)
OLT	12,100
ONU	350
Ethernet Switch	1,800
Splitter 1 × 2	50
Splitter 1 × 16	800
Fiber (/Km)	160

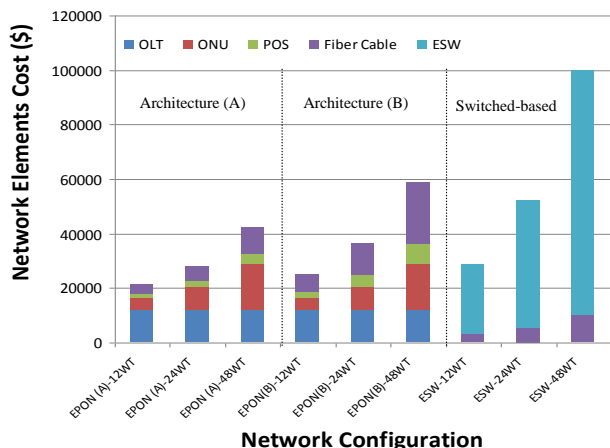

Figure 8. Comparison of Network cost

VI. CONCLUSION

In this paper, we proposed two different communication network architectures based on EPON technology for offshore WPF. In order to evaluate the proposed communication architectures, we consider offshore WPF with 48 WTs which is located 5Km from the shore. The total path loss is analyzed for each wind turbine to assure that optical power budget is sufficient for maintaining an acceptable performance under any conditions. Considering the new power budget classes (PX-30, PX-40), our proposed architectures are valid for the offshore WPF, and the power budget can be also satisfied. This analysis results showed the applicability and robustness of EPON-based communication network architectures that can be applied for next generation WPF. There are two directions of our future works. First is building a simulation model of EPON-based architectures to evaluate network performance such as reliability, packet delay and packet loss in both upstream and downstream direction, considering turbine monitoring and controlling data and a real WPF dimensions. Second direction is considering hybrid network architectures of EPON and IEEE 802.16 (WiMAX) for large-scale WPF. The wireless link of WiMAX can be incorporated into the WPF design as backup link to increase the network reliability.

ACKNOWLEDGMENT

This work was supported by the National Research Foundation of Korea (NRF) funded by the Korea government (MEST) (2012-0009152). Professor Young-Chon Kim is corresponding author.

REFERENCES

- [1] A. L. Pettener, "SCADA and communication network for large scale offshore wind power systems," IET Conf. on Renewable Power Generation, Edinburgh, pp. 1-6, 2011.
- [2] F. Bouhafs, M. Mackagy, and M. Merabti, "Links to the future: communication requirements and challenges in the smart grid," IEEE Power & Energy Magazine, Jan./Feb. 2012, vol. 10, no. 1, pp. 24-32.
- [3] O. Anaya-Lara, N. Jenkins, and J. R. McDonald, "Communications requirements and technology for wind farm operation and maintenance," Int. Conf. on Industrial and Information System, ICIIS, pp. 173-178, Aug. 2006.
- [4] K. Grobe and J.-P. Elbers, "PON in adolescence: from TDMA to WDM-PON," IEEE Communication Magazine, Jan. 2008, vol. 46, no. 1, pp. 26-34.
- [5] L. Zhihong, L. Zhiyong, X. Tao, and S. Liwei, "Exploration and practice of the smart distribution network by Yangiaping power supply Bureau," China Int. Conf. on Electricity Distribution, CICED, Nanjing, pp. 1-6, Sept. 2010.
- [6] H. Jiang, J. Yao, and G. Zhang, "The construction scheme analysis of distant communication systems for subscriber power consumption information acquisition systems," Journal of Int. Council on Electrical Engineering, vol. 1, no. 4, pp. 482-485, 2011.
- [7] H. Huang and H. Zhang, "Application and analysis of long distance EPON in transmission lines monitoring system," Advanced Materials Research, vol. 317-319, pp. 1583-1589, 2011.
- [8] R. Carolsfeld, "Practical experience from design and implementation of IEC 61850 based communications network in large offshore wind installation," Tech. Meeting, CIGRE-AORC, Thailand, pp. 1-8, Oct. 2011.
- [9] W. Yong, W.-G. Xu, and Y.-L. Zhang, "Application analysis on EPON technology applied in communication system of smart substation," Lecture Notes in Electrical Engineering, vol. 154, pp. 1373-1379, 2012.
- [10] A. Ellis and E. Muljadi, "Wind power plant representation in large scale power flow simulation in WECC," IEEE Power & Energy Society Meeting, Pittsburgh, pp. 1-6, Jul. 2008.
- [11] B. Badrzadeh et al., "Wind power plant SCADA and controls," IEEE Power and Energy Society General Meeting, San Diego, pp. 1-7, Jul. 2011.
- [12] I. Lofgren, "Reference Architecture for Wind Power Integration, A Wind Power Plant System Structure based on Analysis of Wind Power Information Flow," Master Thesis, KTH Electrical Engineering, 2009.
- [13] M. Wei and Z. Chen, "An Ethernet LAN based distributed generation system load shedding strategy," IEEE Conf. on Industrial Electronics Society, Melbourne, pp. 819-824, Nov. 2011.
- [14] M. A. Ahmed and Y.-C. Kim, "Network modeling and simulation of wind power farm with switched gigabit Ethernet," Int. Symposium on Comm. and Information Technologies, Australia, pp. 1009-1014, Oct. 2012.
- [15] E. Eriksson, "Wind Farm Layout, A Reliability and Investment Analysis," Master Thesis in Energy Systems Engineering, Uppsala University, Sweden, 2008.
- [16] R. Maclean, "Electrical System Design for the Proposed One Gigawatt Beatrice Offshore Wind Farm," Master Thesis, University of Strathclyde, Sep. 2004.
- [17] G. Kramer, Ethernet Passive Optical Networks, McGraw-Hill, 2005.
- [18] IEEE Std 802.3ah, IEEE-SA Standard Board, Jun. 2004.
- [19] B. Ng, M. Syuhaimi, A. Premadi, and K. Jumari, "Optical power budget and cost Analysis in PON-based i-FTTH," Research Journal of Information Technology, vol. 2, pp. 127-138, 2010.
- [20] X. Zhang, Z. Fu, J. Xu, and M. Hajduczenia, "Extended EPON PMD specification," Extended EPON Task Force, Interim Meeting Material, Minneapolis, USA, May 2012.
- [21] L. Wosinska, J. Chen, and C. P. Larsen, "Fiber access networks: reliability analysis and Swedish broadband market," IEICE Transactions on Communications, vol. E92-B, no.10, pp. 3006-3014, Oct. 2009.