

The Development of ASIC Type GSR Sensor Driven by GHz Pulse Current

Yoshinobu Honkura
Magnedesign Corporation,
Nagoya, Japan
E-mail: yoshinobu.honkura@magnedesign.co.jp

Shinpei Honkura
Nanocoil Corporation,
Nagoya, Japan
E-mail: shinpei.honkura@nanocoil.co.jp

Abstract—In this paper, we observed the GSR effect driven by GHz pulse current expressed by sine functionality to increase with increasing of the pulse current frequency. These features are explained by spin rotation with GHz rotation speed.

Keywords—GSR sensor; GMI sensor; GHz pulse.

I. INTRODUCTION

Highly sensitive micro magnetic sensors based on amorphous wire, such as FG sensor [1] introduced in 1987, GMI sensor [2] introduced in 1999 and GSR sensor [3] introduced in 2015, have progressed in both of sensitivity and size for extending Internet of Things (IoT) applications. FG sensor and MI sensor have been used for electronics compass [1][2][4], for automotive use, and smart phones [7]. These three types of sensors are based on the same principle allowing to measure the voltage V_c of the coil surrounding the amorphous wire proportional to the external magnetic field on passing pulse current through the wire, resulting that they have the same element structures of these sensors and the same design of these electronics circuits.

The sensitivity is expected in principle to be dependent on $V_c \propto \sqrt{f \cdot N \cdot \mu H}$, where f means frequency, N is coil turn numbers and μ is wire permeability. These pulse current frequencies of FG sensor, MI sensor and GSR sensor have increased from KHz pulse and MHz pulse [9] to GHz pulse in turn. It resulted that GSR sensor shows the largest sensitivity per element volume.

The deference of frequency brings different electro-magnetic phenomena, even if the same amorphous wires are used. FG sensor detects the rotation of axial magnetization generated in whole cross section of the wire induced by KHz pulse current. MI sensor based on skin effect induced by MHz pulse current detects the rotation of axial magnetization of the skin layer of the wire which is arisen by the movement of 90 degree magnetic wall [9] existing close to the surface [5]. GSR sensor detects a new phenomenon to make the spin rotation of the electronic spin existing on the surface with tilt angle toward axis direction dependent on the magnetic field which is arisen by GHz pulse current so that it can give a sine functional output relationship between coil voltage and

magnetic field as well as good linearity, no hysteresis and low noise. We named the above new phenomenon GSR effect.

The sensitivity of GSR sensor is increased with the increase of the coil turn numbers per length, which can be made by 3 dimensional photolithography technique [9] to produce fine pitched micro coil. The micro coil with the coil pitch of $5.5\mu\text{m}$ and the diameter of $16\mu\text{m}$ is produced by this new technique. Current GMI sensor has the coil pitch of $30\mu\text{m}$ and the diameter of $32\mu\text{m}$. The new coil has 6 times smaller coil pitch than that of conventional coil. At the same time, the micro coil is produced directly on the protective film of ASIC surface [9], so that this new process can develop a very small ASIC type GSR sensor without the assembling process with ASIC and the element.

This paper presents 1) the features of GSR sensor, 2) a new process to produce micro coil and 3) development of various ASIC type GSR sensors suitable for different applications.

II. RESEARCH ON GSR EFFECT

A. Principle of GSR effect

The principle of GSR effect induced in the amorphous wire with zero magnetostriction is explained using Figure 1. The wire has a special magnetic domain structure [6] which consists of surface domains with circular spin, axis magnetic domains and 90 degree domain wall existing between two domains. When external magnetic field is applied to the wire along axis direction, electronic spins in surface domains tilt toward the axial direction with the angle dependent on the magnetic field strength. The axis magnetic domains induce axial direction magnetization. GHz pulse current passes through the wire to make strong circular magnetic field and makes only spin rotation with GHz angular velocity but no movement of the domain wall because of strong skin effect induced by GHz current pulse. Figure 2 shows the typical plan structure of GSR element which has one glass coated amorphous wire, 2 wire electrodes and 2 coil electrodes with the size of length of 0.16mm and width of 0.23mm . Figure 3 shows an observed result of the wire voltage and the coil voltage induced by GHz pulse current. The peak coil

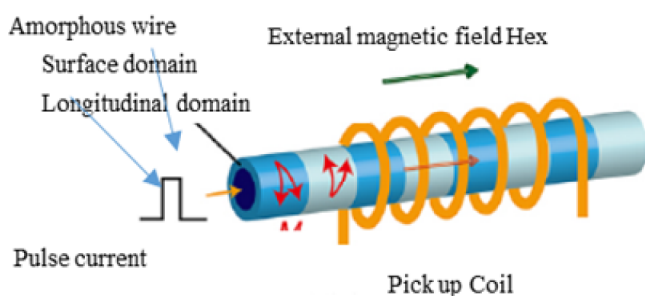

Figure 1. Principle of GSR Effect

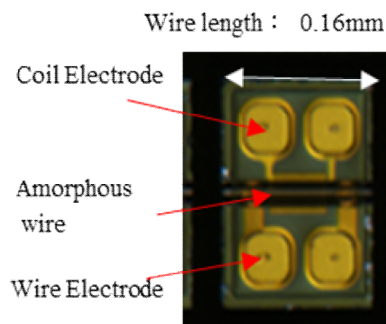

Figure 2. Structure of GSR Element

voltage is induced on the sharp edges of rising and falling of the wire pulse current. It is predicted that 1) GSR effect might increase the coil voltage with the increase of frequency of GHz pulse current and coil turn numbers. 2) The spin rotation not accompanied with domain wall movements could improve magnetic properties of magnetic noise, hysteresis and linearity as well as sensitivity.

B. Experimental Procedure

The present GSR element shown in Figure 2 is equipped with a wire with a composition of $Co_{50.7}Fe_{8.1}B_{13.3}Si_{10.3}$ [8] and the permeability of 1800 with a diameter of $10\mu m$. The tested GSR elements have length of 0.16mm, 0.45mm and 0.96mm, wire resistance of 3Ω 、 8Ω 、 4.5Ω and 13Ω 、coil turn numbers of 14, 32, 66 and 148 and coil resistance of 80Ω 、 210Ω 、 360Ω and 810Ω respectively.

The block diagram and ASIC of electronics circuit for GSR sensor in Figure 4(a) is similar to a conventional GMI circuit [1][2][10] but ASIC used in this research has improvements as follows. The pulse generator can generate pulse currents with frequency of 1GHz to 3GHz. An electronic

switch can operate at a very small interval of 0.1nsec between on and off. An adjustment circuit can control a detection timing from 0 to 4 nsec by interval of 0.1 nsec. The analog circuit has band width of 500 KHz and AD converter has 16 bits. The I2C communication is used to send data to MCU. Consumption current is about 0.4mA @ ODR of 5KHz.

The experiments using GSR sensor produced by connecting with ASIC and GSR elements by wire bonding(Figure 4(b)) are carried out to examine the effects of pulse frequency, detection timing, coil turn numbers and effective permeability on magnetic properties such as sensitivity, relationship between magnetic field and col voltage, measuring rage, linearity, noise and hysteresis. The effect of frequency is examined by changing transition time of pulse current Δt from 0.2nsec to 1 nsec where pulse frequency f is defined by $f=1/2\Delta t$.

C. Results on Features of Coil Voltage of GSR Sensor

A coil voltage of GSR sensor [3] observed under a frequency of 1.5GHz takes a maximum value about the time of 1 nsec and then decreases. The maximum value increases

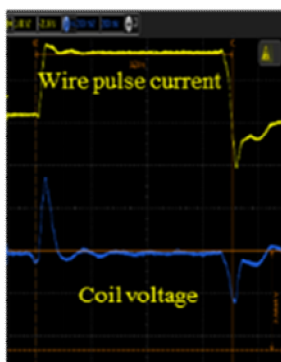

Figure 3. Observed Coil Voltage

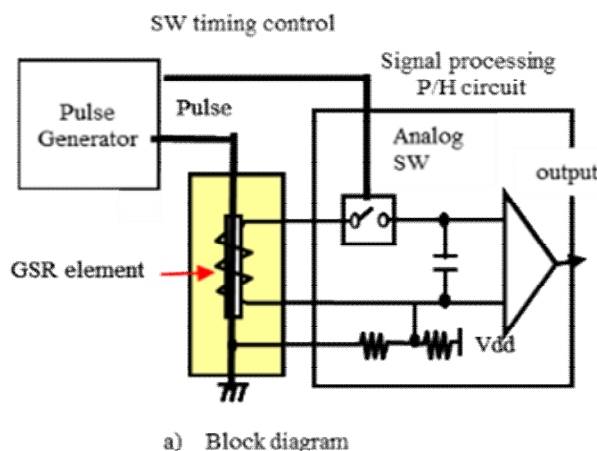
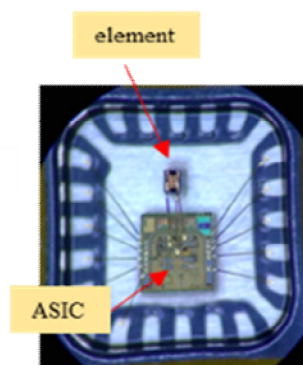

Figure 4. The Circuit of GSR Sensor



a)ASIC used in the test

with increase of magnetic field and takes opposite value by positive and negative. It is noted that coil voltages at $H=0$ A/m which means electric signal voltage is very small compared to that at $H=720$ A/m which means magnetic signal voltage. A relationship between the coil voltage and the magnetic field at the maximum detection timing of the falling process is shown in Figure 5. There is a surprising result that the relationship ship has a sin function expressed by an equation as $V=V_0 \cdot \sin(\pi H/2H_m)$ where H_m is defined as the field strength taking V_{max} . The experimental data results show that H_m is nearly equal to the anisotropy H_k of the amorphous wire, that is, $H_m = 0.96H_k$.

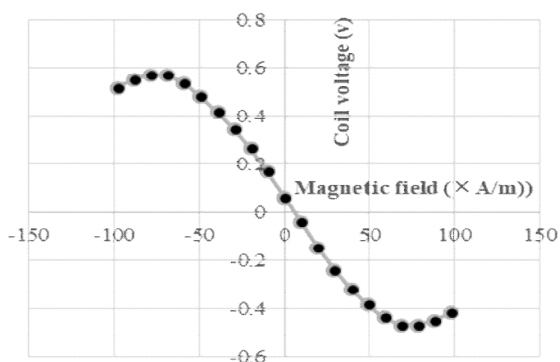

Figure 5. Coil Voltage vs Magnetic Field

Figure 6 shows both linear lines of an inversed voltage by $\pi H/2H_m = \arcsin(V/V_0)$ and a regression line. It is found the linear relationship between coil voltage and magnetic field gives good linearity of 0.5% FS and an extension of the measuring range of 960 A/m (linear approximation) to 7200 A/m (dependent on H_m). On the contrary, GMI sensor output is based on BH curve of amorphous wire without mathematical equation so that a collinear approximation is used not to extend the measuring range. The narrow

measuring range of GMI sensor is one of big disadvantage.

D. Results on Sensitivity of GSR Sensor

The effect of pulse current frequency on the sensitivity of GSR sensor type of length =0.26mm is studied by changing from 1GHz to 3GHz as shown in Figure 7(a). The coil voltage increases with the increase of frequency following saturation over 3GHz. The spins existing in the surface at the angular velocity $\omega (= 2\pi f)$ and the high speed spin rotation excited by GHz pulse current makes the big coil voltage $V(= -\Delta\phi/\Delta t)$. The reason to take saturation over 3GHz is because the actual frequency of the pulse current

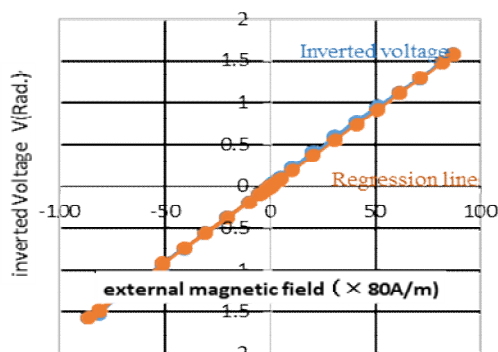

Figure 6. Inverted Coil Voltage vs Regression Line

passing through the wire becomes lower than input frequency due to the strong eddy current. The sensitivity increases proportional to coil turn numbers as shown in Figure 7(b), where coil turn numbers change from 16 turns to 148 turns keeping their wire lengths of 0.96mm. The influences of increase of coil resistance and parasitic capacitance accomplished with increase of coil turn numbers are not affected as long as present test conditions. The sensitivity increases proportional to effective permeability as

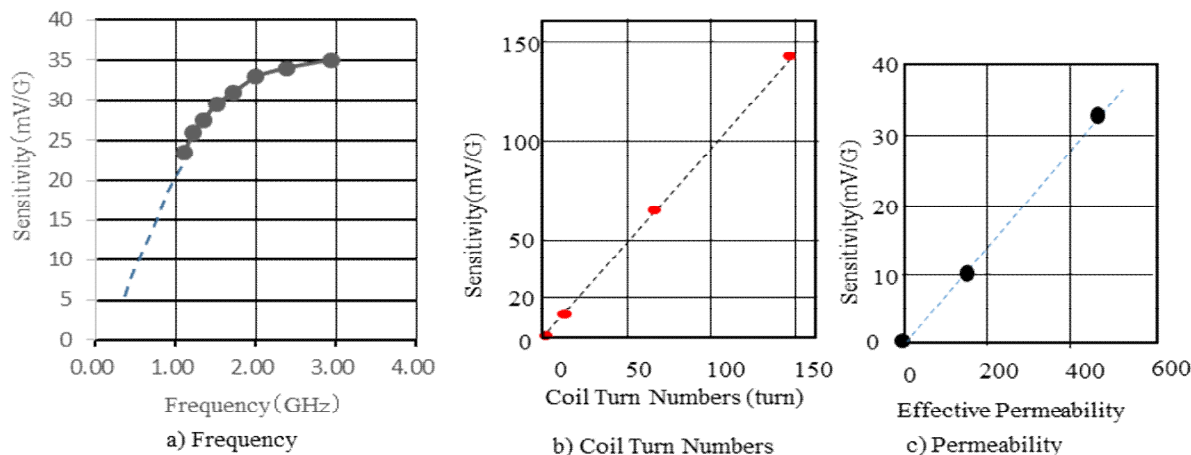

Figure 7. Effect of Frequency, Coil Turn Numbers and Effective Permeability on Sensitivity

shown in Figure 7(c), where wires tested with intrinsic permeability of 1800 and the diameter of 10 μm has effective permeability of 150 and 460 controlled by wire length of 0.16mm and 0.26mm respectively keeping coil turn numbers of 14. It is found that the sensitivity of GSR sensor is effected by pulse frequency, detection type of falling or rising, coil turn numbers and effective permeability.

E. Results on Other Magnetic Properties

It is surprised the rising detection of GSR sensor makes no hysteresis as well as falling detection. GSR effect detects only spin rotation around the wire surface so that hysteresis does not occur. On the contrary, GMI sensor shows a big hysteresis [11] in the case of rising detection because it detects axial magnetization to have the big hysteresis. Rising detection is important for developing high ODR type GSR sensor of over

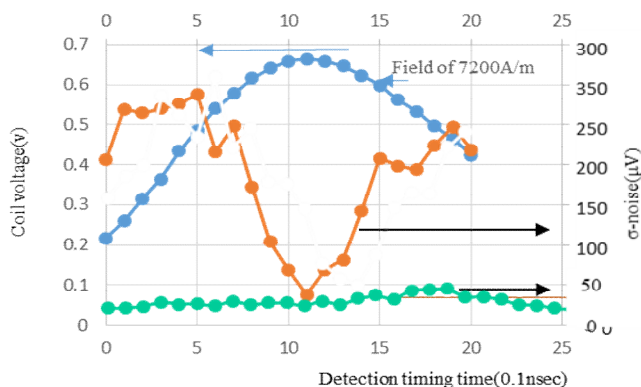

Figure 8. Detection Timing vs σ -Noise

1MHz. It means GSR sensor has bigger potential ability than GMI sensor.

Figure 8 shows the result that σ -noise becomes small to 40 μV under $H=7200$ A/m when falling detection is carried out around peak position of the coil voltage. It means the magnetic noise of GSR sensor occurs only 10 μV because the ASIC has own noise of 30 μV . The frequency of pulse current takes the designated GHz frequency around peak position but around the initial and ending time of pulse current it rises or falls slowly to take low frequency of KHz to MHz. High frequency generates spin rotation accompanied with low noise. Low frequency induces domain wall movement to make big noise proportional to magnetic field strength.

Figure 9 shows effects of tension treatment [10] at room temperature on the sin functional relationship between the coil voltage and the magnetic field. When the tension changes from 76kg/mm² to 10 kg/mm², the sin function shows distortion from sine function. The reason is probably that the tension might enrich the surface domain with circular spins and press the 90 degree domain wall into the inside of the

wire so that the movement of magnetic walls are suppressed and GSR effect to give the correct sine function might occur dominantly.

F. Summary of the Results

We observed GSR effect based on the spin rotation of electron spins existing in surface circular magnetic domain driven by GHz pulse current. The effect makes new features that coil voltage increases with pulse frequency to make big sensitivity and its relationship with magnetic field and coil voltage has the sin functionality to extend the range of linearity as well as it gives non hysteresis and low noise. These features are explained by spin rotation not accompanied with magnetic wall movements.

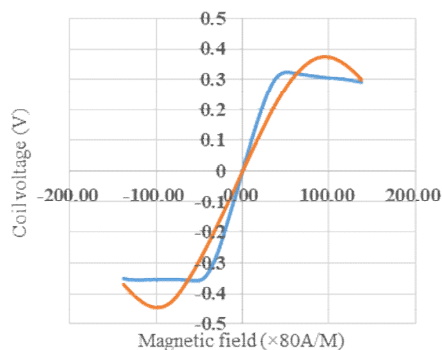

Figure 9. Effects of Tension on Coil Voltage

III. DEVELOPMENT OF 3 DIMENSIONAL PHTOGRAPHY PROCESS FOR A MICRO COIL

We developed a 3 dimensional photography process to produce a micro coil and to put it on the ASIC surface directly. The size of GSR sensor can be drastically downsized by one piece assembling with the element and ASIC as shown in Figure 10. The element is produced through a following process shown in Figure 11 where a glass coated amorphous wire with a diameter of 10 μm has a composition of $\text{Co}_{50.7}\text{Fe}_{8.1}\text{B}_{13.3}\text{Si}_{10.3}$ and permeability of 1800.

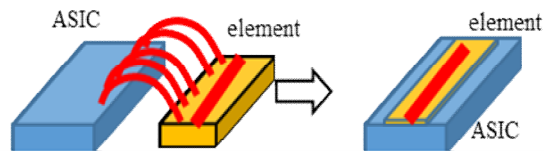

Figure 10. One Piece Assembling with ASIC and GSR Element

The first step is to form a resin film with the thickness of 10 μm and then to make a groove with a width of 18μm and a depth of 7μm on the film by RIE etching. Second step is to produce a bottom coil pattern (Figure 12) with a coil pitch of 5.5μm. The 3 dimensional photolithography makes wire pattern on convex- concave plane controlled by diffraction phenomenon between mask lattice and convexo-concave plane in Figure 13. The coil pitch of 5.5μm can be formed by the combination with mask lattice pitch of 5.5μm and groove depth of 7 μm using the light wave length of 700 nm.

Third step is to set the amorphous wire along the groove using a wire alimant machine in Figure 14. This machine can apply the tension of from 50kg/mm2 to 100kg/mm2 o the wire with the diameter of 10 μm for improving linearity of GSR sensor and can align wires with the alimant interval of ± 1 μm accuracy using the wire as a base line for alimant.

Fourth step is to mold the wire using an adhesive resist. Fifth step is to produce a wire coil pattern (Figure 15) with a coil pith of 5.5μm using 3 dimensional photolithography on the adhesive resist.

The above process can produce a micro coil with the coil pitch of 5.5μm, the coil diameter of 16μm, the wire length of 0.10mm to 2mm and coil turn numbers of 10 turn to 1000 turns on the ASIC surface. GSR sensor can achieve the micro size keeping the good sensor performance.

IV. DEVELOPMENT OF ASIC TYPE GSR SENSOR FOR VARIOUS APPLICATIONS

Various prototype GSR Elements are produced shown in Figure.16. They are divided into one axis type with the length of 0.16mm, 0.45mm and 0.99mm, two axis type and 3axis type.

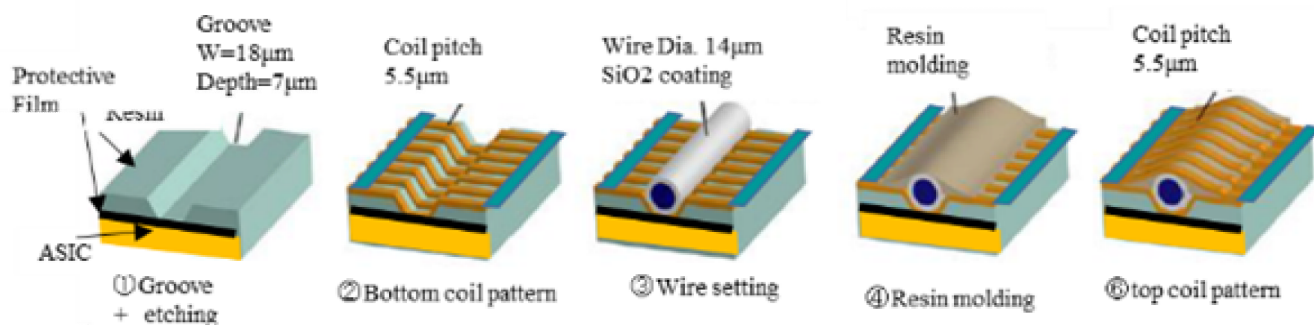

Figure 11. Production Process to Produce GSR Element

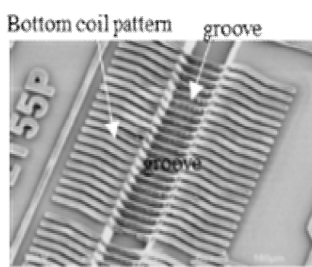

Figure 12. Bottom Coil Pattern on the Groove

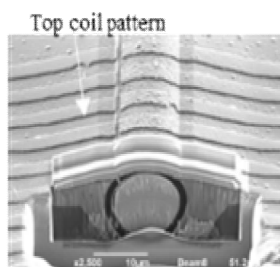

Figure 15. Top Coil Pattern on the Convex

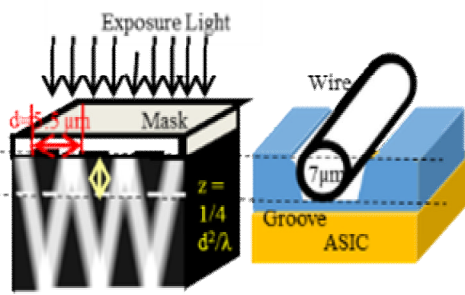

Figure 13. Diffraction Phenomena by Mask Lattice

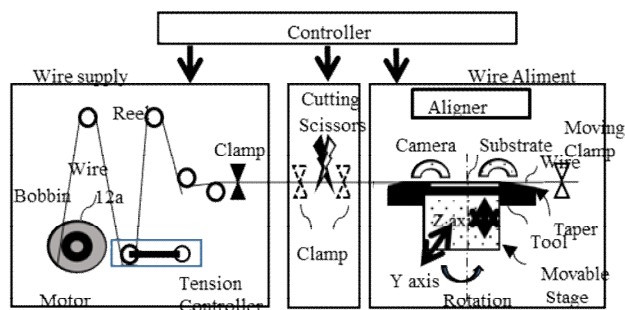

Figure 14. Wire Alimant Machine with the Tension of 76 kg/mm2

Some prototype GSR sensors suitable for specified applications [7] [9] are produced by combination with these elements and the ASIC. The properties of these prototype GSR sensors are shown in Table 1. It is notice that the examination have been carried out using one ASIC which means that their performance are not optimized for all elements. This paper suggests that GSR sensor has good potentiality for some specified applications.

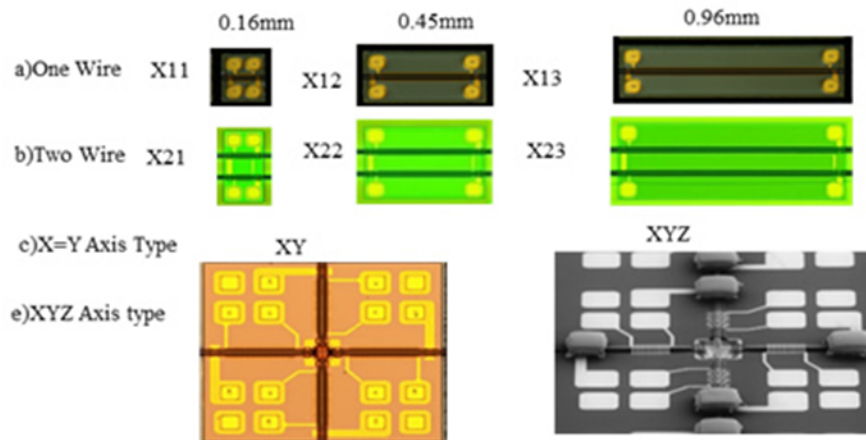

Figure 16. Various Prototype GSR Element

A. Automotive Use Application or Robot Industries

These applications request high accuracy and precise magnetic sensors of 16 to 18 bits which needs to equip wide measuring range of over 80G as well as high sensitivity, good linearity, no hysteresis, low noise, low consumption and wide bandwidth of over 500KHz. Types of X11, X12 and X13 with the wire length of 0.16mm can give the wide measuring range of over 80G and the good linearity of 0.1%FS, almost no hysteresis, low σ -noise of 2mG to 6mG, low current consumption of 0.4mA and 2.4mG(240nT)/LSB in condition of analog circuit bandwidth of 500KHz and ODR of 5KHz. In addition it is well known that amorphous wire type sensors equip strong reliability and temperature stability against outside atmosphere such temperature, magnetic damage and mechanical stress.

GMI sensor had been expected to be most promising sensor for automotive use, but it is not used because of its narrow

measuring range of 12G. The prototype of GSR sensor has wide measuring range of over 80G as well as high total performance 100 times better than that of commercial ASIC type GMI sensor. Here the total performance is calculated by performance index of S/N ratio \times measuring range \times element size.

B. Small Size GSR Sensor for in the Body Use

GSR sensor can make very small size possible because GSR element can be produced directly on ASIC surface. The size of GSR sensor can make the same size of the ASIC size of 1.2mm \times 1.2mm \times 0.1mm which is used in this paper. That means it is promising for in body navigation use.

The magnetic devices with σ -noise of over 10mG for in the body navigation such as catheters, endoscope and so on are used, but they have the poor positioning accuracy of 1-2mm.

TABLE 1. PERFORMANCE OF VARIOUS ASIC TYPE GSR SENSORS

Types	Element Size Length(mm) \times Width (mm)	Resistance Wire/Coil	Coil Turn Numbers	Sensitivity	σ Noise @5KHz		S/N Ratio	Measuring Range	Typical Applications Futures
		Ω	turn	mV/G	μ V	mG	A/m		
X11	0.16 \times 0.23	3/80	14	10	60	6	167	6400	Automotive Wide range
X12	0.45 \times 0.23	7/330	64	63	60	1	1050	2400	Positioning sensitivity
X13	0.90 \times 0.23	14/740	148	140	140	1	1000	Over 800	nT meter High sensitivity
X21	0.22 \times 0.34	6/140	28	13	35	2.7	370	6400	Automotive Wide range
XY	0.26 \times 0.3	6/160	32	30	70	2 (1.4)	430	4000	Encoder 2D
	XY:0.6 \times 0.6								
XYZ	0.26 \times 0.3	6/80	14	16	60	3.8 (2.7)	270	4000	Gyro Compass 3D compass
	XYZ:0.6 \times 0.6								
*MI	0.60 \times 0.35	10/1	16	3.3	70	7	47	960	compass

* Estimated value from Published Data

If types of X12 and X13 with the length of 0.45 mm and 0.90mm respectively with σ -noise of 1mG @ ODR of 5KHz is used, it is expected that the positioning accuracy will improve to under 0.1mm . These applications request long and thin shape sensor. These requests are favorable for direct on-chip type of GSR sensor because wire is long.

C. Compass for Smart Phone and Mobile Computer

Types of XY and XYZ are operated to output 5 data such a X1,X2,Y1,Y2 and temperature @ODR of 1KHz. Type XY for 2D compass consists two X axis coil (X1 and X2) and two Y axis coil (Y1 and Y2) to obtain the magnetic field at the center position by averaging to have noise of 1.4 mG @ ODR of 1KHz and the range of 50G. Type XYZ for 3D compass consists of 2D compass and permalloy parts to detect Z axis magnetic field. The sensitivity for Z axis magnetic field is adjusted by the height of the permalloy part. It is important to form a magnetic circuit by direct connection with the wire and the permalloy parts. It has noise of 2.7mG@ ODR of 1KHz and the range of 50G.

Types of XY and XYZ are designed suitable for next generation type compass which requests noise of under 1mG @ODR of 200Hz and measuring range of 24G compared to current specification of noise of under 10 mG@ ODR of 50 Hz and the range of 12G. The specification means about 20 times higher than conventional one. Types of XY and XYZ are not satisfied to the specification but if ASIC performance or GSR element design are changed to make ODR from 1KHz to 200Hz and the measuring range 50G to 24 G, σ -noise will decrease from 1.4 ~2.7 to about 0.3 ~0.7 to be satisfied with the next generation type compass. Next generation type compass will have high speed and high accuracy so that it can calculate real time 3 dimensional attitude. That is, the next generation type compass will mean a magnetic Gyro-Compass with gyro functionality without Vibration gyro. This type of GSR sensor must be promising for smart phone mobile computer, drone, robots and goggles.

D. pT Sensor for Detecting Biomagnetism

The sensitivity of GSR sensor can increase with the coil turn numbers increased by the long wires or 4 wires of GSR element. Gsr sensor must be promising for these applications. However, the wire resistance of long coil becomes more than 2K Ω so that we need to make a high power electronic circuit with VDD of 5V.

V. CONCLUSION

We found GSR effect based on spin rotation forced by GHz pulse current which makes new features with big sensitivity and the sin functional relationship with magnetic field as well as good linearity, non-hysteresis and low noise. We developed the production technology to produce micro coils directly formed on the ASIC surface which make small size GSR sensor possible. Some prototypes of ASIC type GSR sensor have been produced in consideration for applications such as automotive use, in the body use, gyro –compass use and medical use. It is concluded that GSR sensors have big potentiality to become promising magnetic sensor for many applications.

ACKNOWLEDGMENT

This work was financially supported by the subsidized projects of METI, NEDO and Aichi prefecture of Japan. We wish to acknowledge these supports.

REFERENCES

- [1] Y. Akane, “Magnetic sensors” Japan Patent No.2617498(1987)
- [2] K. Mohri “A micro magnetic sensor based on MI effect” , Japan Patent No.3645116 (1999)
- [3] Y.Honkura, “High Sensitive Micro sized Magnetometer”, United States Patent No: US 9,857,436 B2, Jan. 2, 2018
- [4] Y. Honkura; “The Development of MI sensor and its Applications to Mobile Pone”; AES2012, 2012
- [5] K. Mohri, “Science and technology on magnetic sensors” , Corona Publishing Co. LTD , 1998
- [6] Yu. Kabanov, A. Zhukov, V. Zhukova and J. Gonzalez, “Magnetic domain structure of microwires studied by using the magneto-optical indicator film method, Appl. Phys. Lett. 87, p142507, 2005
- [7] Y. Honkura: “chapter 3: Electronics compass and motion sensor using MI sensor”, new magnetic sensors and their applications, Triceps Co. Ltd, 2013
- [8] A. Zhukov, M. Ipatov, M.Churyukanova, A. Talaat, J.M. Blanco and V.Zhukova, “Trends in optimization of giant magnetoimpedance effect in amorphous and nanocrystalline materials” , J. Alloys Compound. 727 (2017) 887-901
- [9] Y. Honkura: “ chapter 5 section4: Development of high sensitive micro magnetic sensor based on GSR effect” , 「 new magnetic sensors and their applications」 Technical Information Institute Co. LTD (2018)
- [10] Y. Honkura; “Equipment and the method to line up magnetic wires on Si wafer, Japanese Patent No. 5839530 (2015)
- [11] Y. Honkura: “Magnetic sensor”, Japan patent No.3801194(2006)