

Performance Analysis of MIMO Satellite Communications Via Multiple Terrestrial Non-Regenerative Relay Nodes

Styliani Fassoi, Emmanouel T. Michailidis, and Athanasios G. Kanatas

Department of Digital Systems
School of Information and Communication Technologies
University of Piraeus
80 Karaoli & Dimitriou St., 18534, Piraeus, Greece
{sfassoi, emichail, kanatas}@unipi.gr

Abstract—Multiple-input multiple-output (MIMO) satellite communication systems have received the attention of the research community over the last years. This paper proposes a downlink MIMO satellite-to-terrestrial (S2T) system aided by multiple amplify-and-forward (AF) terrestrial relay nodes. This system intends to provide robust, reliable, and efficient communication links and improve the spectral efficiency and the total capacity of the network. In particular, this paper mainly concentrates on investigating the performance of the proposed system and evaluating the bit-error-rate (BER) and the channel capacity. To model the satellite and terrestrial channel, the Loo and Rician statistical distributions are utilized, respectively. One major implementation difficulty of the MIMO technology is the signal separation (detection) problem at the receiving side of the communication link due to interference from multistream transmission. In this paper, the linear zero-forcing (ZF) and minimum mean square error (MMSE) multi-antenna signal detection techniques are employed. To improve the performance without significantly increasing the complexity, ordered successive interference cancellation (SIC) techniques are also exploited.

Keywords—Amplify and forward (AF) relaying; multiple-input multiple-output (MIMO) systems; satellite communications; signal detection techniques

I. INTRODUCTION

As new requirements for access to comprehensive broadband and broadcast/multicast high-speed wireless communication services are emerged, satellite communications can play an important role in the evolution of current and future communication systems by providing global coverage and ubiquitous access [1], [2]. Satellite networks intend to substantially support terrestrial backhaul networks and provide uninterrupted radio coverage to fixed, portable, and mobile terrestrial receivers. The development of next-generation communication systems envisages the synergetic and seamless integration of heterogeneous terrestrial and satellite networks with different capabilities, providing voice, text and multimedia services. Hybrid satellite-terrestrial networks are a typical example of cooperation between different architectures.

For the terrestrial infrastructure, the multiple-input multiple-output (MIMO) architecture has fulfilled the

growing demands for high data throughputs and enhanced link reliability [3]. In recent years, theoretical and experimental efforts have been also devoted by academia and space agencies to the investigation of the applicability of multiple-antenna techniques to satellite systems and the potential enhancements that can be achieved through spatial and/or polarization diversity [4], [5].

The advantages of MIMO technology can be combined with the features of cooperative diversity techniques via intermediate relays [1], [6]-[9], in order to improve the quality of service (QoS), extend the network range, and preserve the end-to-end communication between a source and a destination. The most usual and well-defined types of relaying are the non-regenerative relaying, e.g., amplify-and-forward (AF) relaying, and the regenerative relaying, e.g., decode-and-forward (DF) relaying. In the first type, the relay is a conventional repeater, which just amplifies the received signal and forwards it to the destination. In the second type, the relay has an active role being able to decode the received signal, perform baseband signal processing, and retransmit the signal to the final destination.

In [10], [11], the use of relaying in a single-antenna hybrid satellite-to-terrestrial (S2T) communication system was proposed, whereas the performance of a single-antenna hybrid S2T multi-relay cooperative system was analyzed in [12]. Besides, a MIMO S2T communication system with a single terrestrial relay was proposed in [13]. The benefits regarding the outage probability, the symbol-error-rate (SER) and the ergodic capacity of a S2T communication system with a single multi-antenna relay compared to a conventional single-antenna relay system was underlined in [14]. Indeed, research on multi-relay networks with MIMO-enabled nodes remains limited. A cooperative multi-relay MIMO system, where every terminal in the network is employed with multiple antennas was presented in [15]. However, this system does not consider the special characteristics of the satellite radio channel.

This paper investigates the performance of a downlink MIMO S2T communication system with multiple terrestrial relay nodes in terms of the bit-error-rate (BER) and the available channel capacity. To model the satellite channel, the Loo statistical distribution is used [16]. Besides, the terrestrial channel is modeled using the Rician distribution. Since the receiver often observes a linear superposition of

separately transmitted information that cannot be easily separated, this paper utilizes the linear zero-forcing (ZF) [17] and the minimum mean square error (MMSE) [18] signal detection techniques, which are characterized by computational simplicity compared to non-linear techniques. Moreover, the ordered successive interference cancellation (SIC) techniques are employed to enhance the performance without significantly affect the complexity at the receiver [19].

The rest of the paper is organized as follows. Section II presents a MIMO multi-relay S2T system. In Section III, the satellite and terrestrial radio channels are statistically modeled using widely accepted statistical distributions. Section IV focuses on signal detection techniques. Results are provided in Section V. Finally, conclusions and future research perspectives are drawn in Section VI.

II. SYSTEM MODEL OF THE MULTIPLE-INPUT MULTIPLE-OUTPUT SATELLITE-TO-TERRESTRIAL MULTI-RELAY COMMUNICATION SYSTEM

In this section, a downlink MIMO S2T communication system is considered, where R full-duplex (FD) AF terrestrial relays (R) are assigned to assist the source (S), i.e., the satellite, in forwarding its information to the destination (D), i.e., terrestrial station. Although half-duplex (HD) relaying offers interference-free transmission at the cost of inefficient resource utilization, FD relaying has received significant attention and many studies suggest that by allowing a certain amount of loop-interference (LI), improved performance can be harvested compared to HD relaying [20]. It is assumed the antennas at the relays are isolated and that perfect LI cancellation is feasible. It is also assumed that the direct link between source and destination is obstructed due to high attenuation. The communication system comprises R intermediate relay nodes equipped with M_r transmit and M_t receive antennas, where $M_r = M_t$. Besides, N_t and N_r antennas are used at the source and the destination, respectively. Fig. 1 depicts the communication scenario, whereas Fig. 2 demonstrates the system model.

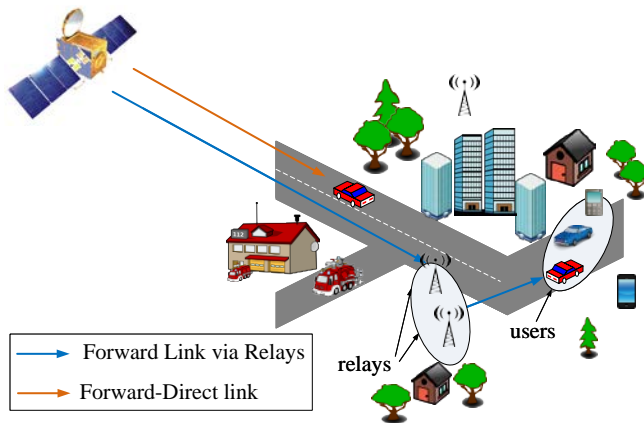

Figure 1. Simple representation of a multi-relay S2T system.

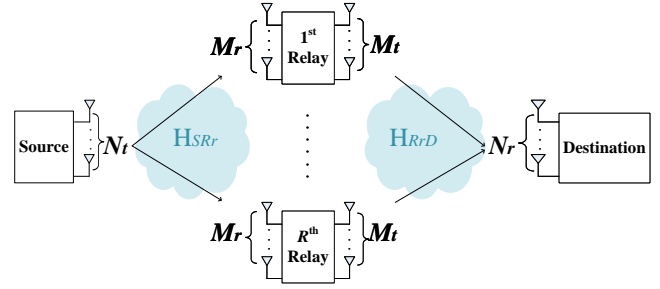

Figure 2. The system model of a MIMO multi-relay S2T system.

Note that the generalization to the case, where each relay has a distinct number of transmit and receive antennas can also be similarly incorporated in the following analysis but at the expense of a more complicated notation. The waves emitted from the source antennas travel over paths with different lengths and impinge the relays' antennas. Then, the relay nodes amplify and forward the received signal to the destination. The transmitted data consists of N_t independent data streams, which are allocated to the correspondingly numbered antennas at the source and relay nodes. The link between the source and the relays represents the satellite link, while the link between the relays and the destination can be modeled as a terrestrial link. Data are transmitted in N -symbol packets. All wireless radio channels are assumed uncorrelated, unless otherwise specified, with frequency-flat block fading, where the coherence time is equal to the duration of the N -symbol packet. Note that the entire system can be separated into $2R$ MIMO subsystems related with the communication link between the source and each relay, as well as each relay and the destination. It is considered that each relay processes the received signals independently.

First, the MIMO subsystem for the communication link between the source and the r th relay is considered. For this subsystem, the $M_r \times 1$ received signal at the r th relay for the i th symbol is given by

$$\mathbf{y}_{R_r} [i] = \mathbf{H}_{SR_r} [i] \mathbf{x} [i] + \mathbf{n}_{R_r} [i], \quad (1)$$

where the matrix \mathbf{H}_{SR_r} is the r th $M_r \times N_t$ MIMO channel matrix (analytically presented in Section III), \mathbf{x} is the $N_t \times 1$ input data vector satisfying $\mathbf{R}_x = E[\mathbf{x}\mathbf{x}^H]$, where $E[\cdot]$ is the statistical expectation operator, and $(\cdot)^H$ denotes the complex conjugate (Hermitian) transpose operator, and \mathbf{n}_{R_r} is the $M_r \times 1$ noise vector with additive white Gaussian noise (AWGN) at the r th relay's branches, whose variance is $\sigma_{SR_r}^2$, the autocorrelation matrix is $\sigma_{SR_r}^2 \mathbf{I}_{SR_r}$, and the covariance matrix is $\mathbf{R}_{nR_r} = E[\mathbf{n}_{R_r} \mathbf{n}_{R_r}^H]$. The

signal received by all the relays can be expressed using an $M_t R$ -element vector $\mathbf{y}_R [i] = [\mathbf{y}_{R_1}^T [i] \mathbf{y}_{R_2}^T [i] \cdots \mathbf{y}_{R_R}^T [i]]^T$ as follows [21]

$$\mathbf{y}_R [i] = \mathbf{H}_{SR} [i] \mathbf{x} [i] + \mathbf{n}_R [i], \quad (2)$$

where $\mathbf{H}_{SR} [i] = [\mathbf{H}_{SR_1}^T [i] \mathbf{H}_{SR_2}^T [i] \cdots \mathbf{H}_{SR_R}^T [i]]^T$ is the $M_t R \times N_t$ channel matrix between the source and the relays, and \mathbf{n}_R is an $M_t R \times 1$ AWGN vector at the relays with $\mathbf{R}_{nR} = E[\mathbf{n}_R \mathbf{n}_R^H]$.

For the MIMO subsystem of the communication link between the r th relay and the destination, the $N_r \times 1$ received signal at the destination is the summation of the R relayed signals [15] and is given by

$$\mathbf{y}_D [i] = \sum_{r=1}^R a \mathbf{H}_{R_r D} [i] \mathbf{y}_{R_r} [i] + \mathbf{n}_D [i], \quad (3)$$

where a is the amplification factor, which is assumed identical for each relay branch, $\mathbf{H}_{R_r D}$ is the r th $N_r \times M_t$ MIMO channel matrix (analytically presented in Section III), \mathbf{y}_{SR_r} is defined in (1), and \mathbf{n}_D is the $N_r \times 1$ noise vector with AWGN at the destination's branches, whose variance is $\sigma_{R_r D}^2$, and the autocorrelation matrix is $\sigma_{SR_r}^2 \mathbf{I}_{SR_r}$, and the covariance matrix is $\mathbf{R}_{nd} = E[\mathbf{n}_D \mathbf{n}_D^H]$. The summation of (3) can be expressed in a more compact form as follows

$$\mathbf{y}_D [i] = a \mathbf{H}_{RD} [i] \mathbf{y}_R [i] + \mathbf{n}_D [i], \quad (4)$$

where $\mathbf{H}_{RD} [i] = [\mathbf{H}_{R_1 D} [i] \mathbf{H}_{R_2 D} [i] \cdots \mathbf{H}_{R_R D} [i]]$ is the $N_r \times M_t R$ compound channel matrix. The end-to-end signal-to-noise ratio (SNR) of each relay branch can be constructed from the compounded channels of the proposed system, as shown in [15, eq. (53)].

An important prospective feature of multi-relay MIMO communication networks is an increase in the channel capacity. The ergodic channel capacity (in bits/sec/Hz) of a MIMO AF multi-relay system is defined as the expectation of the instantaneous mutual information (MI) between the source and destination. Fundamentally, the MI is given by the difference between the differential entropy and the conditional differential entropy of the received signal at the destination via the relays when the transmit data are known. This can be expressed as [15]

$$I_d (\mathbf{x}; \mathbf{y}_D) = H (\mathbf{y}_D) - H (\mathbf{y}_D | \mathbf{x}). \quad (5)$$

After extensive manipulations presented in [22] and [23], it is obtained that

$$I_d (\mathbf{x}; \mathbf{y}_D) = \log_2 \det \left(\mathbf{I}_{N_t} + E \left[a \mathbf{H}_{RD} [i] \mathbf{y}_R [i] \mathbf{y}_R^H [i] \mathbf{H}_{RD}^H [i] \right] \right) \quad (6)$$

III. STATISTICAL MODELING OF THE SATELLITE AND TERRESTRIAL CHANNEL

The modeling of the satellite channel can be performed via a deterministic or statistical approach. Although the deterministic channel models are accurate, their computational complexity is large. In particular, the application of the deterministic channel models to satellite systems is not practically attractive, since a single satellite beam covers a wide propagation area and the determination of all the relevant paths between the satellite and the terrestrial station is difficult. On the contrary, the statistical channel models express the distribution of the received signal by means of the first-order statistics, such as the probability density function (PDF) or the cumulative distribution function (CDF), and the second-order statistics, such the level crossing rate (LCR) and the average fade duration (AFD). Since multipath and shadowing effects are important in the signal propagation, the statistical models usually assume that the received signal consists of two components, the line-of-sight (LoS) component and the non-line-of-sight (NLoS) component. Then, the relative power of the direct, i.e., LoS, and multipath, i.e., NLoS, components of the received signal is controlled by the Rician factor and the distributions of these two components are usually studied separately.

The statistical models for S2T channels can be characterized into two categories; single state and multi-state models [24]. The single state channel models are described by single statistical distributions and can be used fixed satellite scenarios, where the channel statistics remain constant over the areas of interest. Besides, the multi-state channel models are used for non-stationary time-varying propagation conditions.

In this section, a single-state statistical modeling approach for the satellite and the terrestrial channel is described. Specifically, the satellite channel is modeled using the Loo distribution [16], where the long-term shadowing due to roadside trees affects only the LoS component and is described through a log-normal distribution, whereas the NLoS component is described by a Rayleigh PDF. Hence, the resulting complex signal envelope is the sum of correlated lognormal and Rayleigh processes. The Loo distribution assumes that the foliage not only attenuates but also scatters the radio waves. In addition, the Rician distribution is utilized, in order to model the terrestrial channel. Then, a strong LoS signal also arrives at the receiver branches and the fading envelope follows a Rice distribution.

A. Modeling of the satellite radio channel

As previously mentioned, for the communication link between the satellite and the terrestrial relays, the Loo distribution is used, which was verified experimentally by conducting measurements in rural areas with elevation angles up to 30° [25]. Using the Loo distribution, the channel matrix of the satellite link for the envelope h_{ij} is given by

$$\mathbf{H}_{SR_r} = [h_{ij}] = [\overline{h_{ij}}] + [\widetilde{h_{ij}}] = \overline{\mathbf{H}}_{SR_r} + \widetilde{\mathbf{H}}_{SR_r}, \quad (7)$$

where

$$\begin{aligned} h_{ij} &= |h_{ij}| \exp(j\phi_{i,j}) \\ &= \overline{|h_{ij}|} \exp(j\overline{\phi_{i,j}}) + \widetilde{|h_{ij}|} \exp(j\widetilde{\phi_{i,j}}) \end{aligned} \quad (8)$$

and $\overline{\phi_{i,j}}$, $\widetilde{\phi_{i,j}}$ are uniformly distributed over $[0, 2\pi]$. The first factor represents the log-normal fading, while the second one describes the Rayleigh fading. Therefore, the Loo distribution extracted from (8) is the superposition of the log-normal distribution to model the large-scale fading and Rayleigh distribution for the modeling of small-scale fading. Specifically, the Loo probability density function is given by

$$\begin{aligned} p(|h_{ij}|) &= \frac{|h_{ij}|}{b_0 \sqrt{2\pi\sigma^2}} \\ &\times \int_0^\infty \frac{1}{\overline{h_{ij}}} \exp\left[-\frac{(\ln \overline{h_{ij}} - \mu)^2}{2\sigma^2} - \frac{|\overline{h_{ij}}|^2 + \overline{h_{ij}}^2}{2b_0}\right] I_0\left(\frac{|h_{ij}| \overline{h_{ij}}}{b_0}\right) d\overline{h_{ij}} \end{aligned} \quad (9)$$

where b_0 is the average scattered power resulting from the multipath components, σ and μ are the standard deviation and mean, respectively, and $I_0(\cdot)$ is the zero order modified Bessel function of the first kind.

B. Modeling of the terrestrial radio channel

The terrestrial wireless radio channel is mostly characterized by the surrounding local scatterers in the vicinity of the terrestrial nodes, which produce multipath components. Since a strong LoS component is also present, the propagation environment can be characterized using the Rician distribution as follows [26]

$$\mathbf{H}_{R_r,D} = \sqrt{\frac{K_r}{K_r+1}} \overline{\mathbf{H}}_{R_r,D} + \sqrt{\frac{1}{K_r+1}} \widetilde{\mathbf{H}}_{R_r,D}, \quad (10)$$

where K_r is the Rician factor, which expresses the relative power of the direct and scattered components of the

received signal for the link between the r th relay and the destination and provides an indication of the link quality, $\overline{\mathbf{H}}_{R_r,D}$ is a deterministic unit rank matrix, which represents the direct component, and $\widetilde{\mathbf{H}}_{R_r,D}$ is the channel matrix of the multipath components. When $K_r = 0$ the channel is described by a Rayleigh distribution, whereas a very large value of K_r , i.e., $K_r \rightarrow \infty$, implies the presence of a Gaussian channel.

Recent studies have shown that the performance of MIMO systems strongly depends on the Rician factor [27]. In particular, as the Rician factor increases, the correlation between MIMO subchannels also increases [28]. Hence, efficient and accurate methods for estimating the Rician factor are of considerable interest [29]. Several values of the Rician factor have been reported in the literature from measurement campaigns and studies performed in the L- and S- frequency bands for satellite communications systems [30]. According to these measurements, the value of the Rician factor depends on the elevation angle of the satellite and the operating frequency. Nevertheless, the value of the Rician factor also depends on the propagation area, and the degree of urbanization. Thus, the Rician factor is expected to be lower in highly urbanized areas, where the scatterers are usually dense.

IV. LINEAR SIGNAL DETECTION SCHEMES

In MIMO systems, spatial multiplexing is exploited, where multiple streams of independent data are transmitted from the transmitting antennas. These streams should be then separated at the receiver by means of appropriate processing techniques. Hence, signal detection is required for the signals. In this paper, standard linear signal detection methods for MIMO spatial multiplexing systems are used due to their simplicity, versatility, well-understood characteristics, and ease of extracting performance metrics. In linear signal detectors, a linear transform is applied to the outputs of conventional matched filters to produce a new set of outputs, which may generate better results. These detectors treat all transmitted signals as interferences except for the desired stream from the target antenna at the transmitter. Therefore, interference signals from other antennas are minimized or nullified in the course of detecting the desired signal from the target antenna. To facilitate the detection of signals from each antenna, the estimated symbols are inverted by a weight matrix \mathbf{W} as follows [22]

$$\tilde{\mathbf{x}} = [\tilde{x}_1 \tilde{x}_2 \cdots \tilde{x}_{N_t}]^T = \mathbf{W}\mathbf{y}, \quad (11)$$

where $\mathbf{y} = \mathbf{H}\mathbf{x} + \mathbf{n}$ is the receive vector, \mathbf{H} is the channel matrix, \mathbf{x} is the transmit vector, and \mathbf{n} is the noise vector for a generic MIMO communication system. Hence, a linear combination of the received signals in the destination node is considered. Note that there is one detection for each

symbol, which depends on the number of the transmit antennas. The standard linear detection methods include the well-defined and widely used ZF and MMSE linear signal detection techniques.

The simplest MIMO detector is the ZF detector, which simply inverts the channel matrix and attempts to completely remove (forced to zero) the interference caused by the channel. For the case when the inverse of the channel does not exist, the pseudoinverse of the channel matrix is used. The ZF detection technique assumes that the base station has perfect knowledge of the channel state information (CSI) of all users' equipment present at the receiver.

The weight matrix of the ZF technique is given by [22]

$$\mathbf{W}_{ZF} = (\mathbf{H}^H \mathbf{H})^{-1} \mathbf{H}^H, \quad (12)$$

where $(\cdot)^H$ is the Hermitian transpose operation. Thus, we obtain

$$\begin{aligned} \tilde{\mathbf{x}}_{ZF} &= \mathbf{W}_{ZF} \mathbf{y} \\ &= (\mathbf{H}^H \mathbf{H})^{-1} \mathbf{H}^H (\mathbf{H} \mathbf{x} + \mathbf{n}) \\ &= \underbrace{(\mathbf{H}^H \mathbf{H})^{-1} \mathbf{H}^H \mathbf{H} \mathbf{x}}_1 + (\mathbf{H}^H \mathbf{H})^{-1} \mathbf{H}^H \mathbf{n} \\ &= \mathbf{x} + (\mathbf{H}^H \mathbf{H})^{-1} \mathbf{H}^H \mathbf{n}. \\ &= \mathbf{x} + \tilde{\mathbf{n}}_{ZF}, \end{aligned} \quad (13)$$

where $\tilde{\mathbf{n}}_{ZF} = (\mathbf{H}^H \mathbf{H})^{-1} \mathbf{H}^H \mathbf{n}$. Note that the ZF detector performs poorly when the channel matrix is close to being singular, since it amplifies the noise. On the other hand, when the channel matrix is orthogonal, this suboptimal linear detector does not amplify the noise, and is equivalent to a decision feedback or non-linear maximum likelihood (ML) detector [31]. The latter is considered as an optimal complex technique in the sense of minimum error probability, when all data vectors are equally likely, and it fully exploits the available diversity.

The noise enhancement effect plaguing the ZF detection technique can be reduced by using the MMSE detection technique, which is also considered suboptimal. To maximize the post-detection signal to interference plus noise ratio (SINR), the MMSE weight matrix is given by [22]

$$\mathbf{W}_{MMSE} = (\mathbf{H}^H \mathbf{H} + \sigma^2 \mathbf{I})^{-1} \mathbf{H}^H. \quad (14)$$

The MMSE receiver uses the statistical information of noise σ^2 . Thus, using the MMSE weight in (11), we obtain

$$\begin{aligned} \tilde{\mathbf{x}}_{MMSE} &= \mathbf{W}_{MMSE} \mathbf{y}_2 \\ &= (\mathbf{H}^H \mathbf{H} + \sigma^2 \mathbf{I})^{-1} \mathbf{H}^H (\mathbf{H} \mathbf{x} + \mathbf{n}) \\ &= \underbrace{(\mathbf{H}^H \mathbf{H} + \sigma^2 \mathbf{I})^{-1} \mathbf{H}^H \mathbf{H} \mathbf{x}}_1 + (\mathbf{H}^H \mathbf{H} + \sigma^2 \mathbf{I})^{-1} \mathbf{H}^H \mathbf{n} \\ &= \mathbf{x} + (\mathbf{H}^H \mathbf{H} + \sigma^2 \mathbf{I})^{-1} \mathbf{H}^H \mathbf{n}. \\ &= \mathbf{x} + \tilde{\mathbf{n}}_{MMSE}, \end{aligned} \quad (15)$$

where $\tilde{\mathbf{n}}_{MMSE} = (\mathbf{H}^H \mathbf{H} + \sigma^2 \mathbf{I})^{-1} \mathbf{H}^H \mathbf{n}$.

Although non-linear reception offers performance advantages in MIMO systems by assisting in the mitigation of the multi-antenna interference, the linear detection methods are characterized by low complexity in terms of hardware implementation. To improve their performance without significantly increasing their complexity associated with other non-linear methods, ordered SIC techniques can be exploited. These techniques consider a bank of linear receivers, each of which detects one of the parallel data streams, such that the detected signal components successively canceled from the received signal at each stage. The signal is first obtained in the detection step of each propagation path signal. Then, the signals are combined to detect each substream. More specifically, the detected signal in each stage is subtracted from the received signal so that the remaining signal with the reduced interference can be used in the subsequent stage [22].

Fig. 3 illustrates the ordered SIC signal detection process for four spatial streams, i.e., $N_t = 4$. Let us denote x_i the symbol to be detected in the i th order, which may be different from the transmit signal at the i th antenna, since $x_{(i)}$ depends on the order of detection. Let $\tilde{x}_{(i)}$ denote a sliced value of $x_{(i)}$. In ordered SIC techniques, symbol estimation can be obtained using a linear detector, such as ZF or MMSE. The first stream is estimated with the first row vector of the ZF and MMSE weight matrix in (13) and (15), respectively.

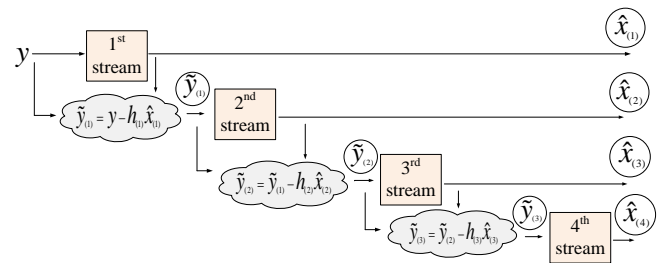

Figure 3. Illustration of the ordered SIC signal detection for four spatial streams.

Providing that $x_{(1)} = \hat{x}_{(1)}$, the interference is successfully canceled in the course of estimating $x_{(2)}$. However, if $x_{(1)} \neq \hat{x}_{(1)}$, error propagation is incurred, since the MMSE weight, which was designed under the precondition of the equality $x_{(1)} = \hat{x}_{(1)}$, is used for the estimation of $x_{(2)}$. Due to the error propagation caused by erroneous decision in the previous stages, the order of detection has significant influence on the performance of ordered SIC detection. For the SIC-ZF technique, we obtain

$$\tilde{\mathbf{x}}_{SIC-ZF} = \mathbf{W}_{ZF} \tilde{\mathbf{y}}_i, \quad (16)$$

where $\tilde{\mathbf{y}}_i = \mathbf{y}_D - h_i \tilde{\mathbf{x}}_{ZF}$ for the i th stream estimation. Similarly, for the SIC-MMSE technique, we also obtain

$$\tilde{\mathbf{x}}_{SIC-MMSE} = \mathbf{W}_{MMSE} \tilde{\mathbf{y}}_i, \quad (17)$$

where $\tilde{\mathbf{y}}_i = \mathbf{y}_D - h_i \tilde{\mathbf{x}}_{MMSE}$ for the i th stream estimation.

This paper considers an AF DF multi-relay MIMO system. However, in a more realistic scenario, the capacity of a MIMO channel using a linear detector is given by

$$C_{LD} = \sum_{i=1}^k \log_2(1 + SINR_k), \quad (18)$$

where the $SINR_k$ for each receiver is different. The SINR for the MMSE receiver for the k th spatial stream can be expressed as [32]

$$SINR_k^{MMSE} = \frac{1}{\left[\left(\mathbf{I}_{N_t} + SNR * \mathbf{H}^H (\mathbf{R}_n)^{-1} \mathbf{H} \right)^{-1} \right]_{kk}} - 1, \quad (19)$$

where \mathbf{I}_{N_t} is a $N_t \times N_t$ identity matrix and \mathbf{H}^H is the Hermitian transpose of \mathbf{H} . The SINR for the ZF receiver denoted by $SINR_k^{ZF}$ can be expressed as follows by conditioning on \mathbf{H} [17]

$$SINR_k^{ZF} = \frac{SNR}{\left[\left(\mathbf{H}^H (\mathbf{R}_n)^{-1} \mathbf{H} \right)^{-1} \right]_{kk}}. \quad (20)$$

V. RESULTS

This section demonstrates the performance of the proposed communication system with reference to the BER and the available channel capacity. To investigate the performance of the MIMO multi-relay S2T system, two scenarios are initially examined (see Fig. 4). In the first scenario, a single-relay system is considered with two antennas at the source, relay, and destination. The second scenario includes two synchronized relay nodes each

equipped with single antennas. For the first scenario, the Rician factor is set to 10 dB, whereas for the second scenario, the Rician factor is set to 8 dB for the communication link between the source and the first relay and 10 dB for the communication link between the source and the second relay, respectively.

Fig. 5 demonstrates the end-to-end BER performance for the aforementioned two communication scenarios. QPSK modulation is used, since satellite communications are sensitive to data loss due to the limited resources. According to the results, the best performance is achieved with SIC-MMSE, while the worst with ZF for both scenarios. In addition, the MIMO two-relay S2T system outperforms the MIMO single-relay S2T system.

In Fig. 6, the advantage of the MMSE technique over the ZF technique is depicted in terms of the channel capacity. However, this advantage is nullified as the SNR increases.

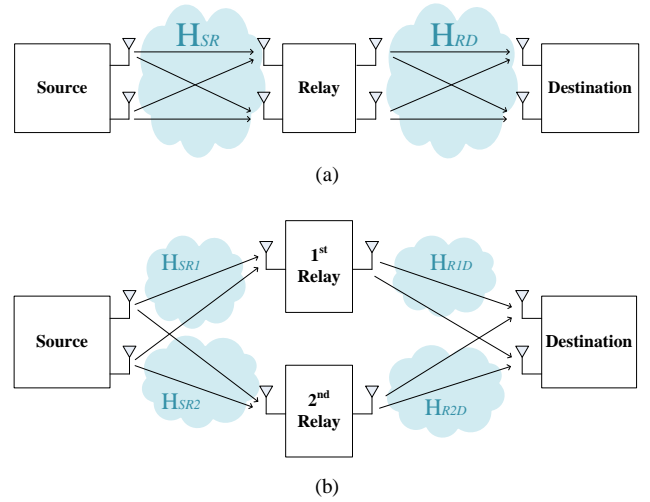

Figure 4. (a) A MIMO single-relay S2T communication system (b) A MIMO two-relay S2T communication system.

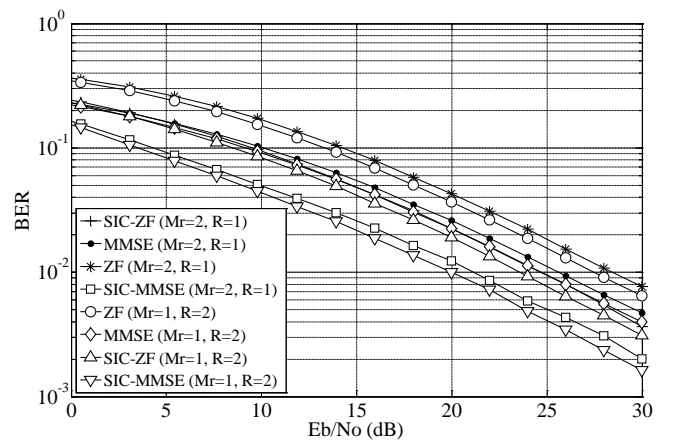

Figure 5. End-to-end BER performance of a MIMO S2T communication system, where a single relay equipped with two antennas or two relays equipped with single antennas are used.

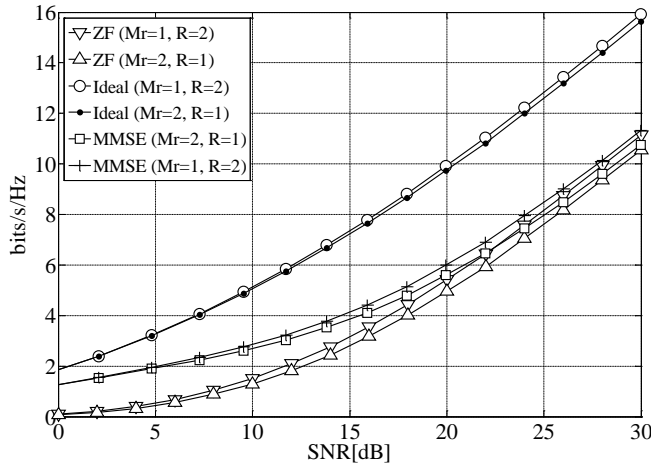

Figure 6. Channel capacity of a MIMO S2T communication system, where a single relay equipped with two antennas or two relays equipped with single antennas are used.

In Fig. 7, different propagation scenarios are examined regarding the BER for a MIMO single-relay S2T system. Specifically, the Loo-Rician, Loo-Rayleigh, Rician-Rician, and Rician-Rayleigh distributions are compared. ZF signal detection is exploited and it is considered that the source, the destination, and the relay are equipped with two antennas. One observes that the performance is better, as soon as the Loo-Rayleigh fading distribution is considered, i.e., the Loo distribution is used for the link between source and relay, whereas the Rayleigh distribution is used for the link between relay and destination.

The effect of the Rician factor, which controls the strength of the LoS component is demonstrated in Fig. 8, where identical values of the Rician factor are used for the different links. In particular, the BER performance degrades as the Rician factor increases. Overall, the results in Figs. 7 and 8 confirm that the MIMO advantages can be successfully exploited in propagation environments, which are characterized by a sufficiently large number of non-coherent diffuse components.

In Fig. 9, the effect of the value of the amplification factor on the end-to-end BER performance of a MIMO S2T communication system is illustrated, where a single relay equipped with two antennas and SIC-MMSE techniques are used. One observes that increasing the amplification factor improves the performance.

Fig. 10 shows the end-to-end BER performance of a MIMO single-relay S2T communication system for different digital modulation schemes, i.e., BPSK, QPSK, 8-PSK, and 16-PSK. It is clear that BPSK is the preferred modulation scheme for the proposed system.

Fig. 11 demonstrates the channel capacity as a function of the number of relays and the number of antennas at the relays. The capacity increases as the number of single-antenna relays increases. However, when the relays are equipped with a large number of antennas, increasing the number of relays has an insignificant effect on the capacity.

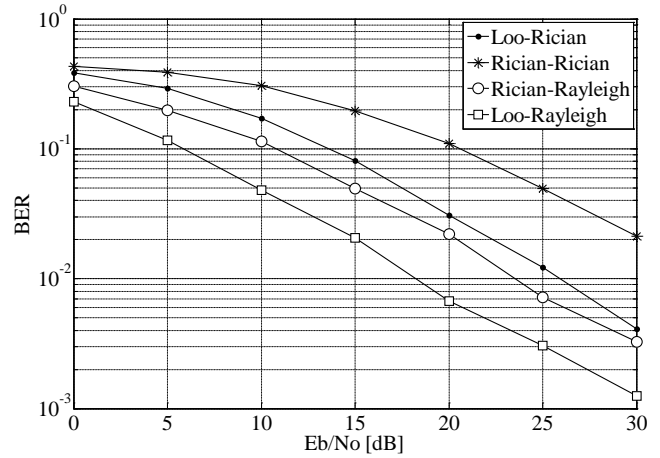

Figure 7. End-to-end BER performance of a MIMO single-relay S2T communication system for different statistical modeling of the satellite and terrestrial channel.

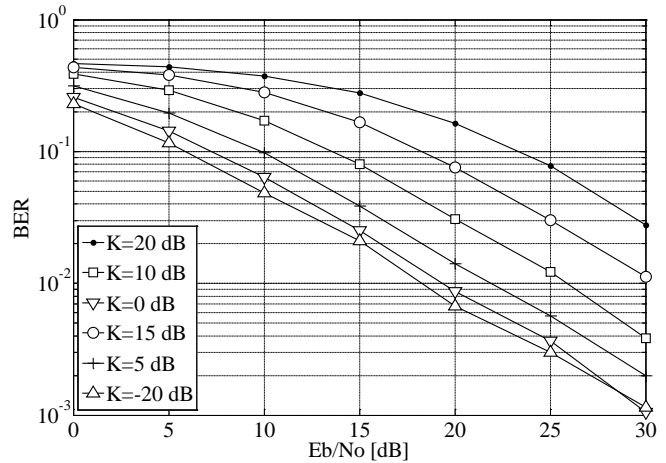

Figure 8. End-to-end BER performance in terms of the Rician factor of a MIMO S2T communication system, where a single relay equipped with two antennas and SIC-MMSE techniques are used.

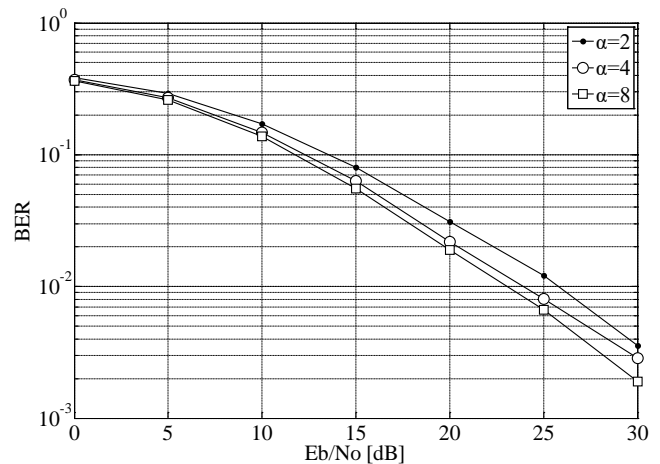

Figure 9. End-to-end BER performance in terms of the amplification factor of a MIMO S2T communication system, where a single relay equipped with two antennas and SIC-MMSE techniques are used.

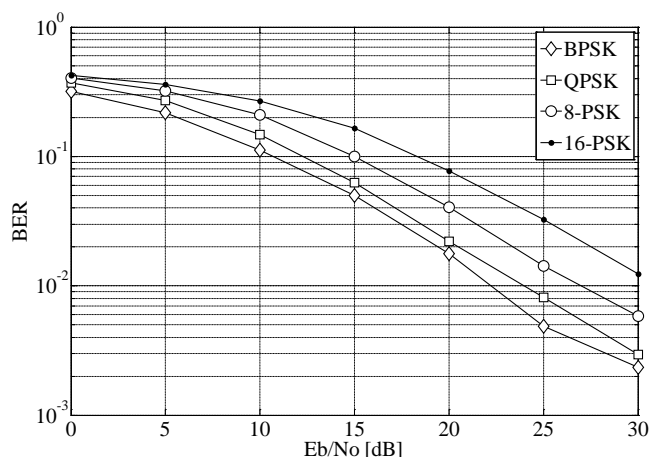

Figure 10. End-to-end BER performance of a MIMO S2T communication system, where a single relay equipped with two antennas and different digital modulation techniques are used.

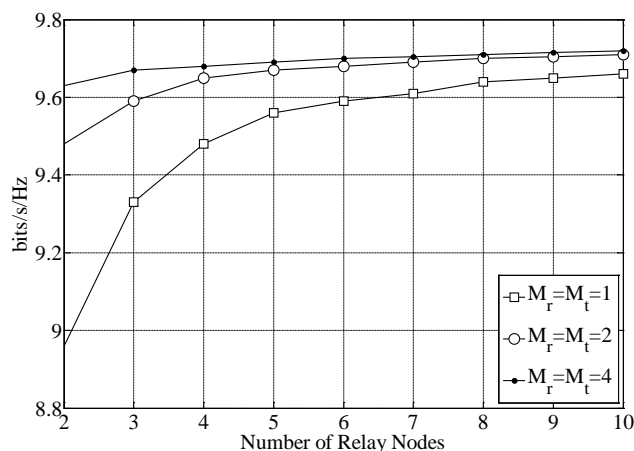

Figure 11. Channel capacity of a MIMO S2T communication system for different number of relays and different number of antennas at the relays.

VI. CONCLUSION AND FUTURE WORK

In this paper, the benefits of using multiple antenna techniques in relay-based S2T systems have been demonstrated. Specifically, the performance of a MIMO S2T communications via single or multiple AF relays for the forward link has been investigated. The results have shown the gain in the BER and the achievable channel capacity by applying ZF, MMSE, SIC-ZF, SIC-MMSE signal detection schemes in different propagation conditions. These results have also underlined that the most promising system model for future reliable wireless networks in difficult terrains and/or high distances is the one that uses BPSK modulation and SIC-MMSE signal detectors.

Nevertheless, this work could be further improved or extended into different areas. Due to the lack of channel-sounding measurement campaigns, the contribution of this

work has been limited to theoretical results. However, it is important to verify this results in real-world propagation conditions. Moreover, other relaying techniques, such as DF relaying, and more sophisticated signal detection techniques, such as the non-linear ML and Tomlinson-Harashima Precoding (THP) techniques, may be exploited, in order to involve additional signal processing and improve error rate performance. The direct link from the source to the destination could be also considered in addition to the indirect source to destination link via the relay nodes, in order to construct a cooperative communication system and test its performance. Finally, multi-beam techniques based on the sufficient spatial separation of the users on ground and proper partitioning of the coverage area can be also exploited, in order to further increase the spectral efficiency of MIMO S2T multi-relay systems.

REFERENCES

- [1] S. Fassoi, D. Christopoulos, S. Chatzinotas, E. T. Michailidis, A. G. Kanatas, and B. Ottersten, "Terrestrial to Satellite Communications Using Multi-antenna Relays Nodes," in *Proc. 7th International Conference on Advances in Satellite and Space Communications (SPACOMM) 2015*, Barcelona, Spain, pp. 46-51, 19-24 Apr. 2015.
- [2] B. Evans, M. Werner, E. Lutz, M. Bousquet, G. E. Corazza, G. Maral, and R. Rumeau, "Integration of Satellite and Terrestrial Systems in Future Multimedia Communications," *IEEE Wireless Communications*, vol. 12, no. 5, pp. 72-80, Oct. 2005.
- [3] A. J. Paulraj, D. A. Gore, R. U. Nabar, and H. Bölcskei, "An Overview of MIMO Communications - A Key to Gigabit Wireless," *Proceedings of the IEEE*, vol. 92, no. 2, pp. 198-218, Feb. 2004.
- [4] P.-D. Arapoglou, K. Liolis, M. Bertinelli, A. Panagopoulos, P. Cottis, and R. De Gaudenzi, "MIMO over Satellite: A Review," *IEEE Communications Surveys & Tutorials*, vol. 13, no. 1, pp. 27-51, First Quarter 2011.
- [5] P.-D. Arapoglou, E. T. Michailidis, A. D. Panagopoulos, A. G. Kanatas, and R. Prieto-Cerdeira, "The Land Mobile Earth-Space Channel: SISO to MIMO Modeling from L- to Ka- Bands," *IEEE Vehicular Technology Magazine*, vol. 6, no. 2, pp. 44-53, Jun. 2011.
- [6] A. Nosratinia, T. E. Hunter, and A. Hedayat, "Cooperative communication in wireless networks," *IEEE Commun. Mag.*, vol. 42, no. 10, pp. 74-80, Oct. 2004.
- [7] R. U. Nabar, H. Bölcskei, and F. W. Kneubuhler, "Fading relay channels: Performance limits and space-time signal design," *IEEE J. Sel. Areas Commun.*, vol. 22, no. 6, pp. 1099-1109, Aug. 2004.
- [8] B. Paillassa, B. Escrig, R. Dhaou, R., M.-L. Boucheret, and C. Bes, "Improving satellite services with cooperative communications," *Int. J. Satell. Commun. Network.*, vol. 29, no. 6, pp. 479-500, Nov./Dec. 2011.
- [9] Y. Fan and J. Thompson, "MIMO Configurations for Relay Channels: Theory and Practice," *IEEE Trans. on Wireless Communications*, vol. 6, no. 5, pp. 1774-1786, May 2007.
- [10] M. K. Arti, "Channel Estimation and Detection in Hybrid Satellite-Terrestrial Communication Systems," *IEEE Trans. on Vehicular Technology*, vol. 65, no. 7, pp. 5764-5771, Jul. 2016.
- [11] V. K. Sakarellos, C. Kourogiorgas, and A. D. Panagopoulos, "Cooperative hybrid land mobile satellite-terrestrial broadcasting systems: Outage probability evaluation and accurate simulation," *Wirel. Pers. Commun.*, vol. 79, no. 2, pp. 1471-1481, Nov. 2014.
- [12] Y. Bu, M. Lin, K. An, et al., "Performance Analysis of Hybrid Satellite-Terrestrial Cooperative Systems with Fixed Gain Relaying," *Wirel. Pers. Commun.*, vol. 89, no. 2, pp. 427-445, Jul. 2016.
- [13] Y. Dhungana, N. Rajatheva and C. Tellambura, "Performance Analysis of Antenna Correlation on LMS-Based Dual-Hop AF MIMO Systems," *IEEE Trans. on Vehicular Technology*, vol. 61, no. 8, pp. 3590-3602, Oct. 2012.

- [14] A. Iqbal and K. M. Ahmed, "Impact of MIMO enabled relay on the performance of a hybrid satellite-terrestrial system," *Telecommun Syst.*, vol. 58, no. 1, pp. 17-31, Jan. 2015.
- [15] P. Clarke and R. C. de Lamare, "Transmit Diversity and Relay Selection Algorithms for Multirelay Cooperative MIMO Systems," *IEEE Trans. on Vehicular Technology*, vol. 61, no. 3, pp. 1084-1098, Mar. 2012.
- [16] C. Loo, "A statistical model for a land mobile satellite link," *IEEE Transactions on Vehicular Technology*, vol. 34, no. 3, pp. 122-127, 1985.
- [17] R. Xu, F.C.M. Lau, "Performance analysis for MIMO systems using zero forcing detector over fading channels," *Communications, IEE Proceedings*, vol. 153, no. 1, pp.74-80, 2 Feb. 2006.
- [18] D. Christopoulos, J. Arnaud, S. Chatzinotas, C. Mosquera, and B. Ottersten, "MMSE performance analysis of generalized multibeam satellite channels," *Communications Letters, IEEE*, vol. 17, no. 7, pp. 1332-1335, 2013.
- [19] M. Mandloi and V. Bhatia, "Ordered iterative successive interference cancellation algorithm for large MIMO detection," in *Proc. IEEE International Conference on Signal Processing, Informatics, Communication and Energy Systems (SPICES) 2015*, Kochi, Kerala, India, pp. 1-5, 19 - 21 Feb. 2015.
- [20] I. Krikidis, H. A. Suraweera, P. J. Smith and Chau Yuen, "Full-duplex relay selection for amplify-and-forward cooperative networks," *IEEE Trans. Wirel. Commun.*, vol. 11, no.12, pp. 4381-4393, Dec. 2012.
- [21] Y. Fu, L. Yang and W. P. Zhu, "A nearly optimal amplify-and-forward relaying scheme for two-hop MIMO multi-relay networks," *IEEE Communications Letters*, vol. 14, no. 3, pp. 229-231, Mar. 2010.
- [22] Y. S. Cho, J. Kim, W. Y. Yang, and C. G. Kang, *MIMO-OFDM Wireless Communications with Matlab*, Wiley, 2010.
- [23] I. Telatar, "Capacity of multi-antenna Gaussian channels," *Eur. Trans. Telecommun.*, vol. 10, no. 6, pp. 585-595, Nov. 1999.
- [24] A. Abdi, W.C. Lau, M.-S. Alouini, M. Kaveh, "A new simple model for land mobile satellite channels: First- and second-order statistics," *IEEE Trans. Wireless Commun.*, vol. 2, no. 3, pp. 519-528, 2003.
- [25] C. Loo and J. S. Butterworth, "Land mobile satellite channel measurements and modeling," in *Proceedings of the IEEE*, vol. 86, no. 7, pp. 1442-1463, Jul. 1998.
- [26] N. Letzepis and A. Grant, "Capacity of the multiple spot beam satellite channel with Rician fading," *IEEE Trans. Inf. Theory*, vol. 54, no. 11, pp. 5210-5222, Nov. 2008.
- [27] V. Tarokh, N. Seshadri, and A. R. Calderbank, "Space-time codes for high data rate wireless communication: Performance criterion and code construction," *IEEE Trans. on Information Theory*, vol. 44, no. 2, pp. 744-765, Mar. 1998.
- [28] A. Abdi and M. Kaveh, "A space-time correlation model for multielement antenna systems in mobile fading channels," *IEEE Journal on Sel. Areas in Commun.*, vol. 20, no. 3, pp. 550-560, Apr. 2002.
- [29] A. Abdi, C. Tepedelenlioglu, M. Kaveh, and G. Giannakis, "On the estimation of the K parameter for the Rice fading distribution," *IEEE Commun. Letters*, vol. 5, no. 3, pp. 92-94, Mar. 2001.
- [30] A. Jahn, "Propagation considerations and fading countermeasures for mobile multimedia services," *Int. Journal on Satellite Commun.*, vol. 19, no. 3, pp. 223-250, 2001.
- [31] W. Peng, S. Ma, T. S. Ng, and J. Wang, "A novel analytical method for maximum likelihood detection in MIMO multiplexing systems," *IEEE Trans. on Communications*, vol. 57, no. 8, pp. 2264-2268, Aug. 2009.
- [32] M. Jing, Z. Ying, S. Xin, and Y. Yan, "On capacity of wireless ad hoc networks with MIMO MMSE receivers," *IEEE Trans. on Wireless Communications*, vol. 7, no. 12, pp. 5493-5503, Dec. 2008.